

Installation and Operation Manual

HyperDeck Disk Recorders

Blackmagicdesign 



Mac OS X™

Windows™

September 2015



Welcome

We hope you share our dream for the television industry to become a truly creative industry by allowing anyone to have access to the highest quality video.

Our range of HyperDeck disk recorders have made it easier and more affordable than ever to record and play back full 10 Bit uncompressed video and now Ultra HD! HyperDeck records directly to removable 2.5" Solid State Disks (SSDs) that are getting bigger, faster and more affordable every day. It's incredible that you can now record and play the most amazing quality video onto something so small thousands of times without any degradation in quality!

SSDs can also be mounted on any computer for immediate editing and fast transfer of your media. With no moving parts, SSDs are unbelievably robust and can handle harsh conditions that would destroy conventional hard drives and videotapes!

You can bypass unwanted camera compression and record directly from HDMI or SDI cameras straight to SSD and even connect to any HDMI or SDI monitor for instant playback! With HyperDeck Studio Pro, you can connect analog sources and also record and play back Ultra HD with 6G-SDI. The HyperDeck Studio 12G model can record even higher frame rates in Ultra HD up to 60 fps!

If you need longer recording times for each SSD, then HyperDeck also records and plays back Apple ProRes and Avid DNx files. These 10 Bit quality codecs retain fantastic picture quality and increase the recording length of SSDs by more than 5 times!

This instruction manual contains all the information you need to start using your HyperDeck disk recorder. For uncompressed recording you need to use an SSD that supports the required data speed and we are continually adding details on our website of new SSDs that we have tested.

Please check the support page at www.blackmagicdesign.com for the latest version of this manual and updates to the HyperDeck software. Keeping your software up to date will always ensure you get all the latest features. When downloading software, please register with your information so we can keep you updated when new software is released. We are constantly working on new features and improvements, so we would love to hear from you!

Grant Petty

Grant Petty
CEO Blackmagic Design

5	Getting Started		
	Getting Started with Blackmagic HyperDeck	5	
	Plugging in Power	5	
	Plugging in Video and Audio	5	
	Plugging in SSDs	6	
8	Recording		
	Recording Ultra HD and HD video with HyperDeck	8	
	Recording Video with HyperDeck Shuttle	8	
	Recording Video with HyperDeck Studio Models	8	
	Ref Input	9	
10	Playback		
	Playing Video with HyperDeck Shuttle	10	
	Playing Video with HyperDeck Studio models	10	
	Ultra HD Playback on HyperDeck Studio Pro	11	
	Shuttling with HyperDeck Shuttle	11	
	Jog or Shuttle with HyperDeck Studio Models	11	
12	HyperDeck Status Indicators		
13	About SSDs		
	Choosing a Fast SSD	13	
	Preparing SSDs	15	
17	Blackmagic HyperDeck Setup		
	Using HyperDeck Setup	17	
	How to Update Your HyperDeck Software on Mac OS X	17	
	How to Update Your HyperDeck Software on Windows	17	
	Selecting Your Video Format	18	
19	Control Panel Display Menu		
	Using the Display Menu on HyperDeck Studio Models	19	
	Selecting Timecode Source	19	
	SDI Start/Stop Recording	20	
	Timecode Run Recording	21	
22	RS-422 Control		
	What is RS-422 Control?	22	
	Using an External RS-422 Controller	22	
	Supported RS-422 Commands	23	
	RS-422 Developer Information	27	
28	Thunderbolt		
	Capturing video via Thunderbolt	28	
	Capturing from SSD	28	
	Simultaneous Capture and Recording	28	
29	SSD Workflow		
	Accessing Your Clips	29	
	Mac OS X	29	
	Windows	29	
	Using Blackmagic MultiDock with HyperDeck	30	
	Connecting to a Computer	30	
	Plugging in Drives	31	
	Identifying Drives	31	
	Formatting Drives	31	

Setting up a RAID for High Speed Performance and Data Security	33	Capturing live via Thunderbolt	47
Configuring a RAID using Mac OS X and Windows	34	Adobe Premiere Pro CC	48
Unplugging your Drives	34	Capturing live via Thunderbolt	49
35 Using DaVinci Resolve		Adobe Photoshop CC	49
Introducing DaVinci Resolve	35	How to grab video frames	49
Importing your Clips	35	50 Using Blackmagic Media Express	
Editing your Clips	36	What is Blackmagic Media Express?	50
Trimming Clips	37	Capturing Video and Audio Files	50
Mapping Keyboard Shortcuts	37	Playing back Video and Audio Files	54
Adding Transitions	38	Browsing Media	56
Adding Titles	38	58 Using Blackmagic UltraScope	
Adding Audio Tracks	39	69 Using Blackmagic Disk Speed Test	
Color Correcting your Clips	39	72 Accessories	
Using Scopes	40	Installing the HyperDeck Shuttle Mounting Plate	72
Secondary Color Correction	41	73 Developer Information	
Qualifying a Color	41	Blackmagic HyperDeck Ethernet Protocol	73
Adding a Power Window	42	Protocol Commands	73
Tracking a Window	42	Protocol Details	75
Using Plugins	43	88 Help	
Mastering your Edit	43	89 Warnings	
45 Using Third Party Editing Software		90 Warranty	
Avid Media Composer	45		
Setting up	45		
Capturing live via Thunderbolt	46		
Apple Final Cut Pro 7	47		
Setting up	47		

5 Getting Started

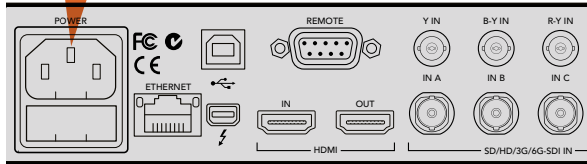
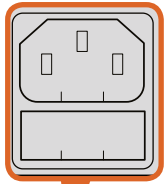

Connect power to your HyperDeck Studio using a standard IEC power cable.

Getting Started with Blackmagic HyperDeck

Getting started with your HyperDeck disk recorder is as easy as connecting power, plugging in your video sources and destination equipment to your HyperDeck's inputs and outputs and inserting your SSDs.

Plugging in Power

For HyperDeck Studio models, simply plug a standard IEC cable to your HyperDeck's power input on the rear panel.

For HyperDeck Shuttle, connecting power will also charge the internal battery. You can disconnect the external power once the battery is charged so your HyperDeck Shuttle is completely portable to record video anywhere. Press the 'power' button to switch it on.

Plugging in Video and Audio

All HyperDeck models have SDI and HDMI inputs and outputs. Plug your source video to the inputs, and your destination equipment to the outputs.

HyperDeck Studio 12G has 12G-SDI connectors so you can input or output Ultra HD up to 2160p60 using a single BNC cable.

HyperDeck Studio Pro provides additional inputs and outputs for connecting video equipment that supports single link, dual link or quad link Ultra HD.

Plugging in Analog Audio and Timecode on HyperDeck Studio Pro

If you want to connect analog audio sources to HyperDeck Studio Pro, plug into the XLR or RCA connectors. To select your desired audio input, simply press the 'input' button on the front control panel to cycle through combinations of video and audio inputs. For example, SDI + XLR, SDI + RCA, and more. External timecode can also be connected to and from your HyperDeck Studio Pro via the timecode XLR input and output connectors.

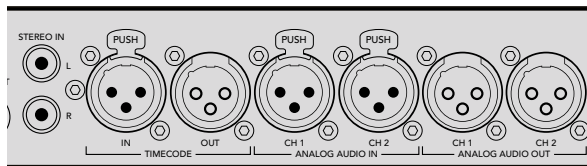

HyperDeck Studio Pro lets you plug in external analog audio and timecode via the rear panel XLR connectors. You can even plug in analog audio from audio equipment such as iPods and HiFi systems via the RCA inputs.

6 Getting Started

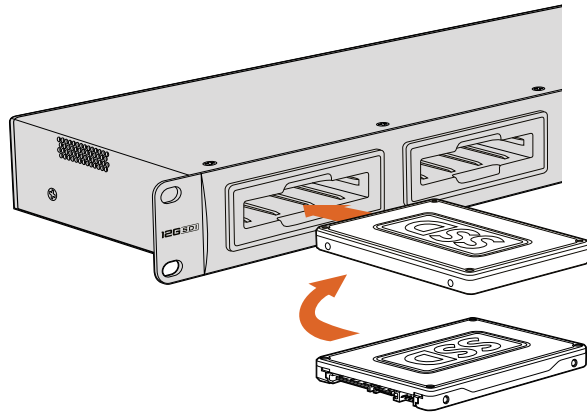

Hold your SSD with the connection pins facing the bottom, aligned with your HyperDeck's drive bay and gently push the SSD into the drive bay until you feel it slot into place.

Plugging in SSDs

All HyperDeck models ship ready to record immediately without having to configure any settings. All you need is a formatted SSD.

If you have a HyperDeck Studio model then you can easily format SSDs via the front LCD based menu settings. You can also format your SSDs using a computer.

Refer to the 'About SSDs' section in this manual for more information on how to format SSDs, the types of SSDs that are best for recording video and a list of recommended media.

To plug an SSD into your HyperDeck:

- Step 1.** Hold a 9.5mm SSD with the connection pins facing the bottom and aligned with your HyperDeck's drive bay. Gently push the SSD into the drive bay until you feel it slot into place.
- Step 2.** Your HyperDeck will verify the SSD. This is shown by an illuminated green light surrounding the drive bay on HyperDeck Studio models, or the flashing SSD indicator on HyperDeck Shuttle. When the light or indicator turns off and the 'stop' button on the control panel is illuminated, your HyperDeck is ready to record.

About Hyperdeck



8 Recording

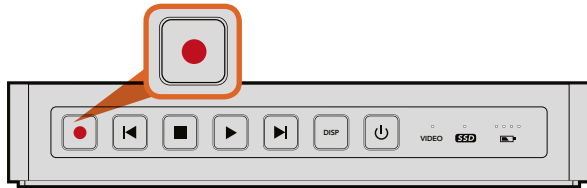

The record button lights up red when HyperDeck Shuttle is recording video.

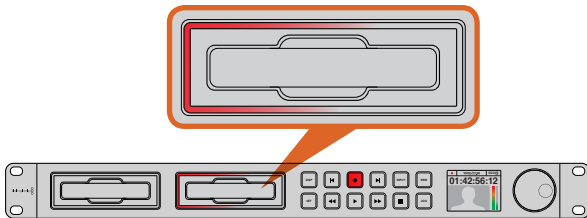

SSD slots on HyperDeck Studio models have rotating LEDs to show the unit is recording video.

Recording Ultra HD and HD video with HyperDeck

HyperDeck models that support Ultra HD video record compressed Ultra HD using Apple ProRes, plus Avid DNxHR on HyperDeck Studio 12G. All HyperDeck models excluding the original HyperDeck Shuttle can record HD video using ProRes and DNxHD codecs, or uncompressed HD video for high definition at the highest quality. The original HyperDeck Shuttle exclusively records uncompressed HD video.

Recording Video with HyperDeck Shuttle

- Step 1.** Insert your formatted SSD. As HyperDeck Shuttle reads the disk, the SSD light will illuminate. When the light stops, HyperDeck Shuttle is ready to record.
- Step 2.** HyperDeck Shuttle automatically detects whether SDI or HDMI is connected. The 'video' status LED lights up when a valid video signal is detected.

HyperDeck Shuttle will default to recording from whichever input was connected first. We recommend connecting only SDI or HDMI at a time as HyperDeck Shuttle will switch inputs if one is disconnected and reconnected.
- Step 3.** Press the 'record' button and the SSD light will flash to indicate SSD activity. If the 'stop' button starts flashing while recording, there are only 3 minutes of recording time left on the SSD.
- Step 4.** Press the 'stop' button to finish recording.

Recording Video with HyperDeck Studio Models

- Step 1.** Insert your formatted SSD into either SSD slot. The LED strip surrounding the drive will illuminate green as HyperDeck reads the disk. When the slot light turns off, HyperDeck Studio is ready to record.
- Step 2.** Press the input button on the control panel to cycle through your HyperDeck's inputs. When your connected source is selected, it will appear on the control panel LCD.

For HyperDeck Studio Pro, pressing the input button will also cycle through combinations of video and audio connections, for example SDI + SDI, SDI + XLR, and SDI + RCA. This lets you record SDI or HDMI video with external audio.

If you want to record using a different codec, you can choose from a variety of codecs using the control panel LCD menu or the HyperDeck Setup utility software. See the 'control panel display menu' section, or 'Blackmagic HyperDeck Setup/selecting your video format' section for more information.

9 Recording

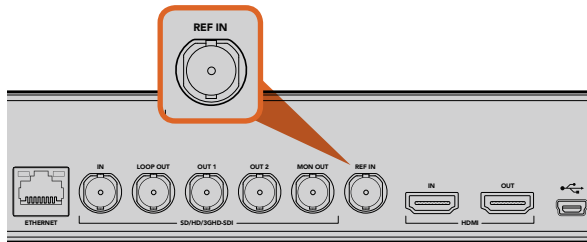

The reference input on HyperDeck Studio models and HyperDeck Studio Pro lets you sync your HyperDeck with other video equipment.

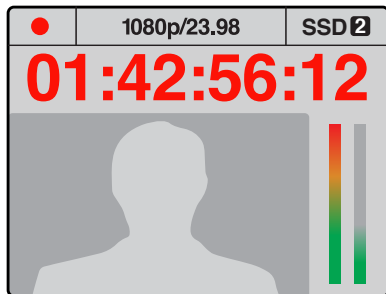

If you have less than three minutes of recording time left on your current SSD and no formatted SSD in your HyperDeck's second SSD slot, the timecode indicator will turn red indicating your recording is about to stop.

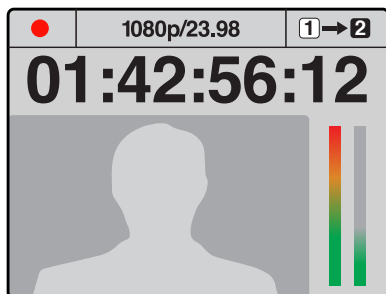

If there is space on a formatted disk in the second SSD slot, HyperDeck will display an icon in the top right corner to indicate that recording will automatically switch over once the current disk is full.

Step 4. Press the 'record' button to start recording instantly. A looping red light on the SSD slot indicates the SSD is recording. All HyperDeck Studio models have dual SSD slots. This lets you automatically continue recording onto another SSD when one is full.

Step 5. Press the 'stop' button to finish your recording.

If the 'record' button flashes slowly, this indicates that the SSD is almost full and is about to stop recording. It also means there is no second disk with space that recording can continue onto. In this case, you simply need to insert a disk with space so recording can continue. Once you insert a blank disk into the slot that's not being used for recording, the slow flashing will stop and this means the HyperDeck Studio can continue to record, because this second disk has been checked ok and there is space to keep recording.

If you want to change the disk you are recording to at any time, and you have a second disk that has free space, then simply hold down the record button and the recording will move from the current disk to the second disk. This is very useful when you want to get that disk out of the HyperDeck without pausing recording. This can happen during live events when you need to get an important recording out to another location, but you don't want to miss anything and you don't want to stop recording.

If the 'record' button flashes quickly, this means the disk is not fast enough for sustained recording. We recommend changing to a compressed recording format such as ProRes or DNxHD, or use a faster recommended SSD for uncompressed or Ultra HD recording.

If HyperDeck records from a video source that contains closed caption data, the QuickTime or MXF movie will be recorded as well as a separate .MCC file containing the closed caption data.

Ref Input

HyperDeck Studio models and HyperDeck Studio Pro feature a Reference input, which accepts black burst and tri-level sync signals from a sync generator. Connect a reference source to this input if you want to synchronize HyperDeck with other video equipment, such as a production switcher.

10 Playback

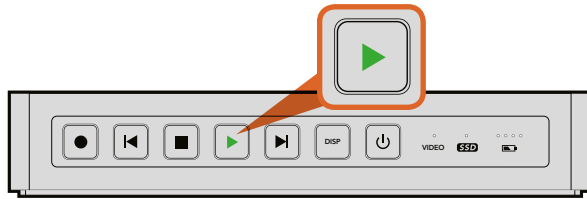

The play button illuminates green when HyperDeck Shuttle is in playback mode.

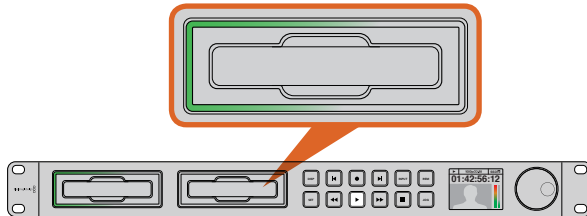

SSD slots on HyperDeck Studio models have rotating LEDs to show the unit is in playback mode.

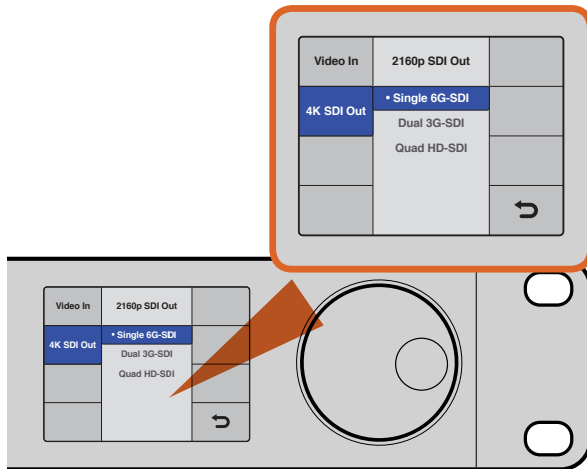

For HyperDeck Studio Pro, you can choose between single link 6G-SDI, dual link 3G-SDI or quad link HD-SDI for Ultra HD playback.

Playing Video with HyperDeck Shuttle

- Step 1.** Press the 'stop' button once to stop recording. Press 'stop' again to switch HyperDeck Shuttle to playback mode.
- Step 2.** Press 'play' and you'll see your video appear on any displays connected to the SDI and HDMI outputs. When a clip is playing, pressing 'play' again will loop it continuously.
- Step 3.** To skip to the next clip, press the next clip button on the shuttle controls. Press previous clip once to go to the start of the current clip or press twice to skip back to the start of the previous clip.

Playing Video with HyperDeck Studio models

- Step 1.** Press the 'play' button once for instant playback and you'll see your video on any displays connected to the SDI and HDMI outputs. When a clip is playing, pressing 'play' again will loop it continuously.

With HyperDeck Studio Pro, you can choose to play back Ultra HD using single link, dual link or quad link outputs. Refer to the 'Ultra HD Playback on HyperDeck Studio Pro' section for more information.

- Step 2.** To skip to the next clip, press the 'next clip' button on the shuttle controls.
- Step 3.** Press 'previous clip' once to go to the start of the current clip or press twice to skip back to the start of the previous clip.

If the play button flashes, this means the disk is not fast enough and playback cannot keep up. We recommend you change to a compressed recording format such as ProRes or DNxHD, or use a faster recommended SSD for uncompressed or Ultra HD recording.

If you play back a video clip that has an associated .MCC file, the closed caption data will be played out with the video via the SDI output of your HyperDeck.

11 Playback

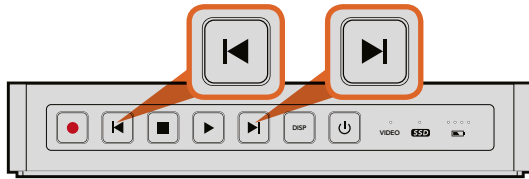

Press and hold the 'previous clip' or 'next clip' button on HyperDeck Shuttle to rewind or fast forward at 2x speed.

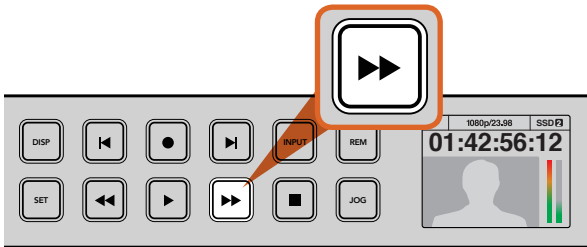

The fast forward button on the front of HyperDeck Studio models lights up when fast forwarding through clips.

Ultra HD Playback on HyperDeck Studio Pro

HyperDeck Studio Pro can play back Ultra HD video via single link 6G-SDI, dual link 3G-SDI, and quad link HD-SDI.

To select your desired Ultra HD playback output:

- Step 1.** Press the 'disp' button to open the control panel LCD menu.
- Step 2.** Using the jog/shuttle wheel and 'set' button, select 'video', then '2160p SDI out'.
- Step 3.** Select your desired output type and press 'set' to confirm. Press the 'disp' button to close the menu.

Shuttling with HyperDeck Shuttle

During playback, press and hold the 'previous clip' or 'next clip' button to rewind or fast forward at 2x speed. Press the 'previous clip' or 'next clip' button again and the speed will increase to 4x and then 8x. Once you've found the section you want to review, press 'play' and playback will resume at normal speed.

Jog or Shuttle with HyperDeck Studio Models

During playback, press the 'reverse' or 'fast forward' button to play through the clip at 2x speed. Press the 'reverse' or 'fast forward' button again and the speed will increase to 4x and then 8x. Once you've found the section you want to review, press 'play' to resume normal playback.

You can also use the jog or shuttle wheel to shuttle to a particular section at variable speeds. The more you turn it forwards or backwards, the faster your HyperDeck Studio will play through your video. Once you've found the section you want to review, press 'play' to resume normal playback.

If you want to slowly jog through your video frame by frame, press the 'jog' button once to enable jog operation. Turning the jog or shuttle wheel in the desired direction will then jog through your video. Pressing the 'jog' button again will return the wheel to shuttle operation.

12 HyperDeck Status Indicators



Status indicators on HyperDeck Shuttle tell you whether your SSD is formatted correctly, whether a video signal is detected and how much battery power is left.

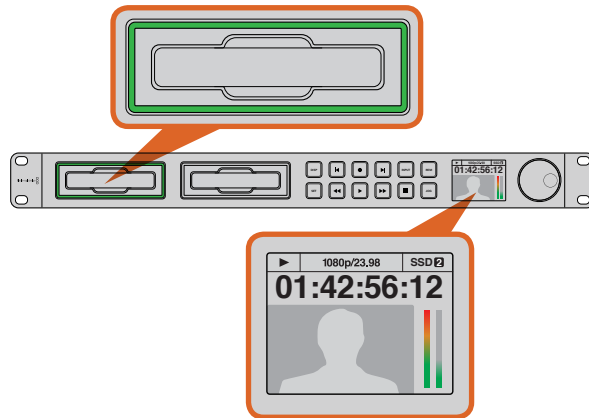

The SSD slots on HyperDeck Studio models indicate if an SSD is formatted correctly and whether the unit is in recording or playback mode. The LCD on HyperDeck Studio models shows your video as well as status information.

Status Indicators

When recording or playing video with HyperDeck, any information you need to know is displayed on the unit itself. HyperDeck Shuttle's backlit buttons and LEDs provide vital information such as when your disk is nearly full and the remaining battery life, whereas HyperDeck Studio models display information on an LCD.

HyperDeck Shuttle

SSD Indicator

When you first switch on HyperDeck Shuttle, or any time you insert an SSD, the SSD indicator will light up while checking the SSD and then switch off. If the SSD has not been formatted correctly, or fails to work, the SSD indicator will illuminate solid red until the SSD is removed. Check if the SSD is formatted correctly and also check that it works with a computer.

Video Indicator

The VIDEO indicator lights up when a video signal is detected by HyperDeck Shuttle.

Battery Indicator

The four green battery indicators display the internal battery charge level. When all the LEDs go off, there's approximately 4 minutes of battery power left. So you should plug in your external power source or switch to another charged HyperDeck Shuttle.

HyperDeck Studio Models

SSD Slot

When you first power on HyperDeck, or any time you insert an SSD, the SSD slot will light up while checking the SSD and then switch off. If the SSD has not been formatted correctly, or fails to work, the SSD slot will illuminate solid red until the SSD is removed. Check if the SSD is formatted correctly and also check that it works with a computer.

LCD

HyperDeck Studio models feature an LCD that not only shows your video but also displays status information such as video format and frame rate, record, playback and jog modes, the active SSD slot as well as timecode and audio levels.

13 About SSDs



Intel 335 Series 240GB SSD



SanDisk Extreme 480GB SSD



Kingston HyperX 240GB SSD

Choosing a Fast SSD

When working with high data rate video it's important to carefully check the SSD you would like to use. This is because some SSDs can have up to 50% lower write speed than the manufacturer's claimed speed, so even though the disk specifications claim an SSD is fast enough to handle video, in reality the disk is not fast enough for real time video recording. Hidden data compression mostly affects recording and often these disks can still be used for real time playback.

In our testing, we have found larger newer models of SSD and larger capacity SSDs are generally faster. SSDs recommended for use with HyperDeck for uncompressed 10 Bit HD and ProRes or DNxHR Ultra HD video recording include:

Brand	SSD Name/Model Number	Storage	Supported Formats	
			10 Bit uncompressed HD and Ultra HD ProRes or DNxHR	HD ProRes and DNxHD
ADATA	XPG SX900. ASX900S3-256GM-C.	256GB	Yes	Yes
Angelbird	AV Pro.	480GB	Yes	Yes
	AV Pro.	240GB	Yes	Yes
Crucial	M4 (firmware 009 only). CT512M4SSD2.	512GB	Yes	Yes
	M4 (firmware 000F only). CT256M4SSD2.	256GB	No	Yes
Digistor	4K Professional Video Series. DIG-PVD1000, pre-formatted exFat.	1TB	Yes (except HyperDeck Shuttle)	Yes (except HyperDeck Shuttle)
	Professional Video Series. DIG-PVD480S, pre-formatted exFat.	480GB	Yes	Yes
	Professional Video Series. DIG-PVD240S, pre-formatted exFat	240GB	Yes	Yes
Intel	520 series. SSDSC2CW480A310.	480GB	Yes	Yes
	520 series. SSDSC2CW240A310.	240GB	Yes	Yes
	530 series. SSDSC2BW240A401.	240GB	Yes	Yes
	530 series. SSDSC2BW180A401.	180GB	Yes	Yes
	335 series. SSDSC2CT240A4K5.	240GB	Yes	Yes
Kingston	HyperX 3K. SH103S3/480G.	480GB	Yes	Yes
	HyperX 3K. SH103S3/240G.	240GB	Yes	Yes
	SSDNow KC300. SKC300S37A/480G.	480GB	Yes	Yes
	SSDNow KC300.SKC300S37A/240G.	240GB	Yes	Yes

14 About SSDs

Brand	SSD Name/Model Number	Storage	Supported Formats	
			10 Bit uncompressed HD and Ultra HD ProRes or DNxHR	HD ProRes and DNxHD
OCZ	Agility 3. AGT3-25SAT3-240G.	240GB	No	Yes
OWC	Mercury Extreme Pro 6G. OWCSSD7P6G480.	480GB	Yes	Yes
	Mercury Extreme Pro 6G. OWCSSD7P6G240.	240GB	Yes	Yes
	Mercury Extreme Pro 6G. OWCSSD7P6G120.	120GB	Yes	Yes
Samsung	850 Pro. MZ-1T0BW, spacer required.	1TB	Yes (except HyperDeck Shuttle)	Yes (except HyperDeck Shuttle)
	850 Pro. MZ-7KE512BW, spacer required.	512GB	Yes	Yes
	850 Pro. MZ-7KE256BW, spacer required.	256GB	Yes	Yes
SanDisk	Extreme Pro. SDSSDXPS-240G-G25.	240GB	Yes	Yes
	Extreme Pro. SDSSDXPS-480G-G25.	480GB	Yes	Yes
	Extreme Pro. SDSSDXPS-960G-G25.	960GB	Yes	Yes
	Extreme. SDSSDX-480G-G25.	480GB	Yes	Yes
	Extreme. SDSSDX-240G-G25.	240GB	Yes	Yes
	Extreme. SDSSDX-120G-G25.	120GB	No	Yes
PNY	Prevail. SSD9SC480GCDA-PB.	480GB	Yes	Yes
	Prevail. SSD9SC240GCDA-PB.	240GB	Yes	Yes
	XLR8. SSD9SC480GMDA-RB.	480GB	Yes	Yes
Transcend	SSD370. TS1TSSD370.	1TB	Yes	Yes
	SSD370. TS512GSSD370.	512GB	Yes	Yes
	SSD370. TS256GSSD370.	256GB	Yes	Yes
	SSD720. TS256GSSD720.	256GB	Yes	Yes

Please visit the Blackmagic Design support center at www.blackmagicdesign.com for the latest support notes and information. If you find an SSD that isn't fast enough for uncompressed HD video or Ultra HD, try a faster SSD or switch to a compressed recording format such as ProRes or DNxHD. These recording formats have a much lower data rate and are easier for the SSD to handle.

15 About SSDs

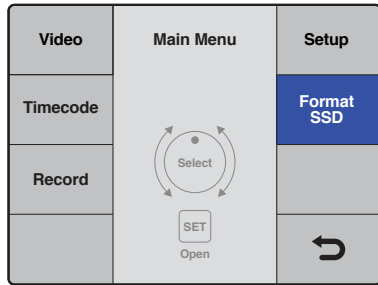

Turn the jog/shuttle wheel clockwise to select format SSD on the LCD menu.

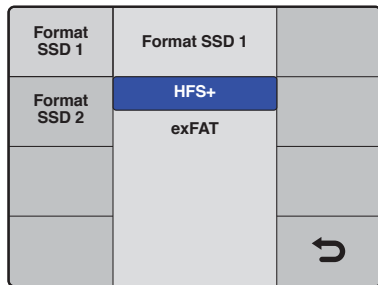

Set your desired format from the HFS+ or exFAT options.

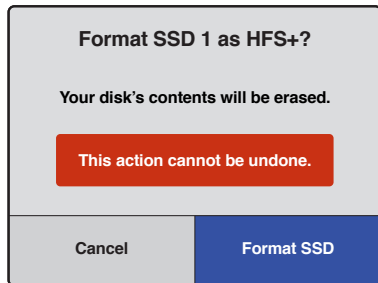

Confirm the format by selecting Format SSD using the jog/shuttle wheel and pressing the set button.

Preparing SSDs

SSDs used by HyperDeck must be formatted as either HFS+ or exFAT. These disk formats allow long clips to be recorded as single files. You can easily format your SSDs using HyperDeck Studio models, or via a computer with an SSD dock or SATA to USB adaptor.

HFS+ is also known as Mac OS Extended and is the recommended format for HyperDeck as it supports journaling. Data on a journaled SSD is more quickly recovered in the rare event your SSD becomes corrupted, and less likely to be corrupted in the first place. HFS+ is natively supported by Mac OS X.

ExFAT is supported natively by Mac OS X and Windows without needing to purchase any additional software. However, exFAT does not support journaling.

While navigating through the format feature on the LCD menu, you'll have plenty of opportunities to cancel the format and return to the previous menu by selecting the return arrow on the bottom right of the LCD, then pressing the 'set' button on the control panel. Always press the 'set' button to confirm settings and enter setting menus.

To format an SSD using your HyperDeck:

- Step 1.** Insert an SSD you want to format into either of the SSD slots.
- Step 2.** Press the 'disp' or 'menu' button on your HyperDeck's control panel.
- Step 3.** Turn the jog/shuttle wheel clockwise to select 'format SSD' on the LCD menu and press the 'set' button to enter the menu.
- Step 4.** Select the SSD you want to format on the LCD using the jog/shuttle wheel. Remember to press the 'set' button to confirm your selection.
- Step 5.** Now set your desired format from the 'HFS+' or 'exFAT' options.
- Step 6.** A warning message will appear on the LCD asking you to confirm the format. Make sure you have backed up any important data before you confirm as this action cannot be undone. Confirm the format by selecting 'format SSD' using the jog/shuttle wheel and pressing the 'set' button.

A progress bar will show you the formatting progress. When your SSD has finished formatting, 'format complete' will display on the LCD. Press the 'set' button again to return to the main menu.

16 About SSDs

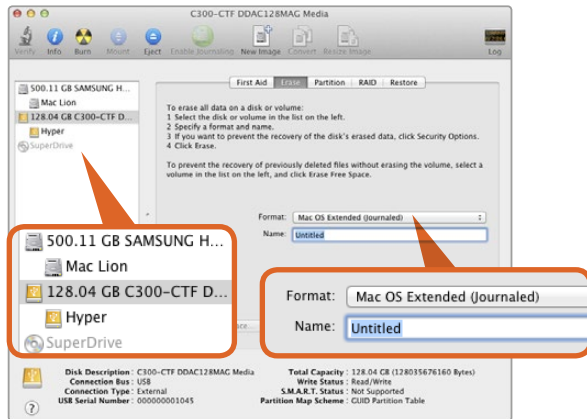

Use Disk Utility on Mac OS X to erase your SSD in the Mac OS Extended (Journaled) or exFAT format.

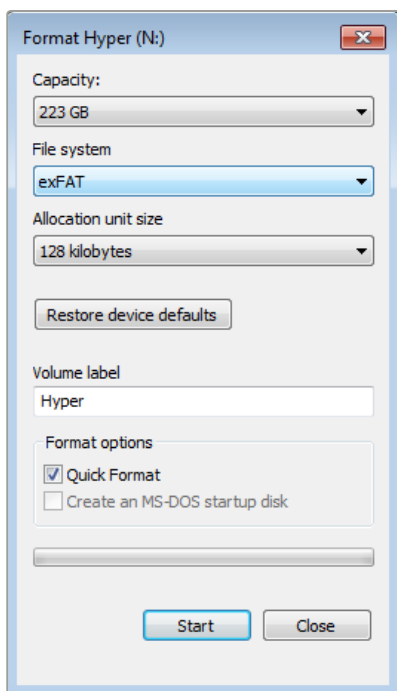

Use the Format dialog box feature in Windows to format your SSD in the exFAT format.

Preparing SSDs on a Mac OS X computer

The Disk Utility application included with Mac OS X can format a drive in the HFS+ or exFAT formats. Make sure you back up anything important from your SSD as you will lose everything on it when it is formatted.

- Step 1.** Connect the SSD to your computer with an external dock or cable adapter and dismiss any message offering to use your SSD for Time Machine backups.
- Step 2.** Go to applications/utilities and launch Disk Utility.
- Step 3.** Click on the disk icon of your SSD and then click the erase tab.
- Step 4.** Set the format to Mac OS Extended (Journaled) or exFAT.
- Step 5.** Type a name for the new volume and then click erase. Your SSD will quickly be formatted and made ready for use with HyperDeck.

Preparing SSDs on a Windows computer

The format dialog box can format a drive in the exFAT format on a Windows PC. Make sure you back up anything important from your SSD as you will lose everything on it when it is formatted.

- Step 1.** Connect the SSD to your computer.
- Step 2.** Open the start menu or start screen and choose computer. Right-click on your SSD.
- Step 3.** From the contextual menu, choose format.
- Step 4.** Set the file system to exFAT and the allocation unit size to 128 kilobytes.
- Step 5.** Type a volume label, select quick format and click Start.
- Step 6.** Your SSD will quickly be formatted and made ready for use with HyperDeck.

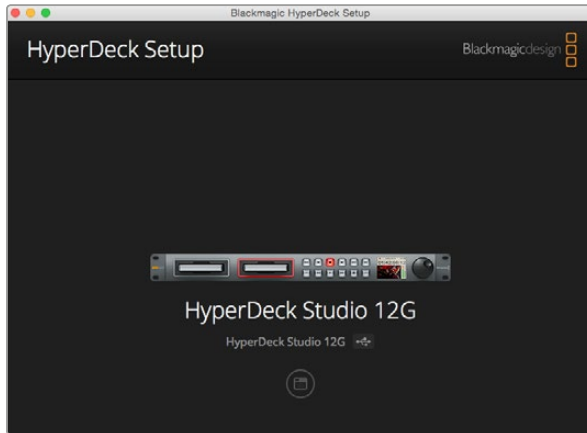

The home page of HyperDeck Setup. If you have multiple HyperDecks connected to your computer, you can choose between them by clicking on the arrows at the sides of the home page.

Using HyperDeck Setup

Blackmagic HyperDeck Setup is used to change settings and update the internal software in your HyperDeck. In addition to installing HyperDeck Setup, uncompressed 10 bit codecs are installed for Mac and Windows. The HyperDeck Installer software also installs Blackmagic Desktop Video Utility which allows your favorite video editing software to perform live capture from HyperDeck Studio Pro via Thunderbolt.

Blackmagic Desktop Video Utility provides a central location so you don't need to configure the same software settings in each video application that you use.

On Mac OS X, open the System Preferences and click the Blackmagic Desktop Video icon. When using HyperDeck Studio Pro, you can change your audio input settings between embedded audio or XLR inputs when capturing video via Thunderbolt. You can also use the Desktop Video utility to check the driver version installed on your HyperDeck Studio Pro and when it was last updated, plus create a status report HTML document containing information about your settings and hardware.

How to Update Your HyperDeck Software on Mac OS X

- Step 1.** Download and unzip the HyperDeck Setup software.
- Step 2.** Open the resulting disk image and launch the HyperDeck Installer. Follow the onscreen instructions.
- Step 3.** After installing, connect a USB cable from HyperDeck to your computer.
- Step 4.** Launch Blackmagic HyperDeck Setup and follow any onscreen prompt to update the internal software in your HyperDeck. If no prompt appears, the internal software is up to date and there is nothing further you need to do.

How to Update Your HyperDeck Software on Windows

- Step 1.** Download and unzip the HyperDeck Setup utility software.
- Step 2.** You should see a HyperDeck Setup folder containing this manual and the HyperDeck Setup utility installer. Double-click the installer and follow the onscreen prompts to complete the installation.
- Step 3.** After installing, connect a USB cable from HyperDeck to your computer.
- Step 4.** Launch Blackmagic HyperDeck Setup and follow any onscreen prompt to update the internal software in your HyperDeck. If no prompt appears, the internal software is up to date and there is nothing further you need to do.

18 Blackmagic HyperDeck Setup

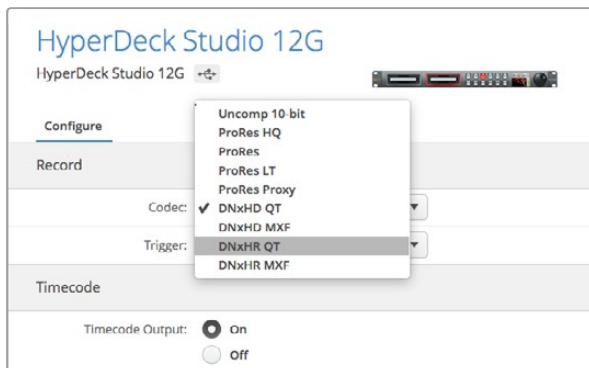

Use HyperDeck Setup to select your desired recording and playback format.

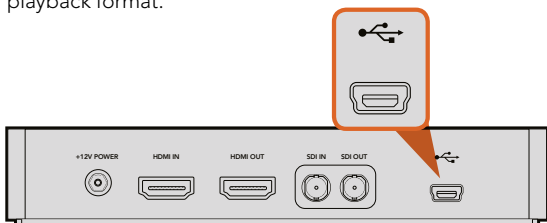

HyperDeck Shuttle USB port.

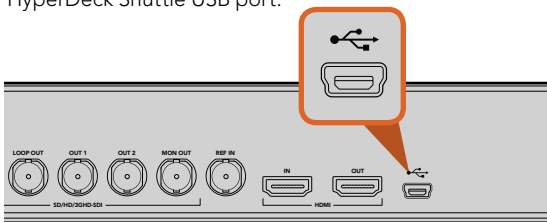

HyperDeck Studio and HyperDeck Studio 12G USB port.

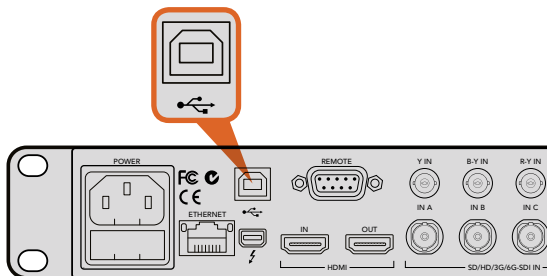

HyperDeck Studio Pro USB port.

Selecting Your Video Format

All current HyperDeck models let you select from a choice of uncompressed and compressed video formats. The original HyperDeck Shuttle exclusively records uncompressed video, while HyperDeck Shuttle 2 also records to ProRes 422 HQ and Avid DNxHD. HyperDeck Studio 12G also supports DNxHR. You can change the codec you want from the front panel LCD menu on all HyperDeck Studio models, or you can use the HyperDeck Setup software utility depending on what you prefer. For more information on how to change your codec using the front panel on HyperDeck Studio models, refer to the 'control panel display menu' section.

HyperDeck can record 10-bit uncompressed QuickTime files on a fast SSD, or to a compressed format if you have a slower SSD or want to fit longer high definition recordings on a single SSD. This means if you have changed the format between recording clips, it is possible to have uncompressed QuickTime files as well as compressed files on the same disk.

Working with uncompressed video is exciting as there is simply no better quality. However, if compressed video better suits your workflow, or if you need to fit more video on a SSD, you can choose a high quality professional compressed video format which is also perfect for editing.

HyperDeck Studio 12G records Ultra HD video using Apple ProRes and Avid DNxHR codecs. HyperDeck Studio Pro records Ultra HD using ProRes codecs.

To choose a video format:

- Step 1.** Connect HyperDeck to your computer via USB.
- Step 2.** Launch HyperDeck Setup. Your HyperDeck model will be named in the setup utility home page.
- Step 3.** Click on the circular 'setup' icon or the image of your HyperDeck to open the settings page.
- Step 4.** In the 'record' settings, click on the 'codec' drop down menu and select your desired codec. Click 'save' to confirm your setting.

All subsequent clips will be recorded in the chosen format.

Setting the recording format also sets the playback format. For example, if you want to play back an uncompressed 10-bit QuickTime file, set the recording format to Uncompressed 10 Bit QuickTime. Setting Avid DNxHD as the recording format lets you play DNxHD QuickTime and MXF clips, and by selecting Apple ProRes you can play clips using any of the ProRes codecs.

ProRes codecs include:

ProRes 422 HQ - For the highest quality compression at the maximum ProRes data rate.

ProRes 422 - For extremely high quality compression using a low ProRes data rate.

ProRes 422 LT - For high quality compression at a lower ProRes data rate.

ProRes 422 Proxy - For high quality offline compression at the lowest ProRes data rate.

ProRes clips will play back using the compression quality they were recorded in.

19 Control Panel Display Menu

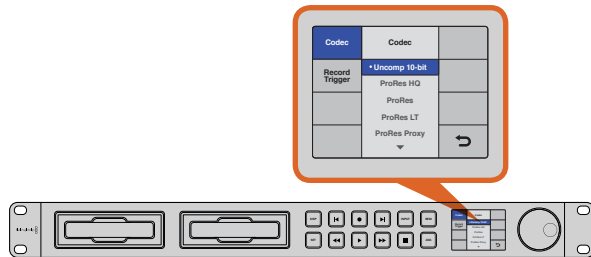

You can use the 'display' or 'menu' button options on HyperDeck Studio models to select between recording in uncompressed, ProRes, or DNxHD. You can also record using DNxHR on HyperDeck Studio 12G. All HyperDeck Studio models include four ProRes codecs.

Using the Display Menu on HyperDeck Studio Models

On HyperDeck Studio models you can use the display menu to change your video and audio inputs and outputs as well as any settings changes you would make in HyperDeck Setup such as trigger recording, timecode output and your chosen recording codec.

- Step 1.** Press the 'display' or 'menu' button to display the main menu.
- Step 2.** Use the jog/shuttle wheel on the front of HyperDeck to highlight different options.
- Step 3.** Press the 'set' button to confirm a selection.
- Step 4.** To return to a previous menu, scroll to the 'return' arrow and press 'set'.
- Step 5.** Press the 'display' or 'menu' button to exit.

Selecting Timecode Source

When recording from HD-SDI video sources that provide embedded SMPTE RP 188 metadata, you can record the embedded timecode from the video source instead of using timecode generated by your HyperDeck.

To set this on HyperDeck Studio models using the display menu:

- Step 1.** Press the 'display' or 'menu' button to display the main menu.
- Step 2.** Scroll to the 'timecode' menu and press 'set'.
- Step 3.** Press 'set' to enter the 'timecode source' menu and select 'input'.
- Step 4.** Press 'set' to confirm your selection.

It might be necessary to turn on the RP 188 setting in your camera before HyperDeck will be able to record the timecode.

20 Control Panel Display Menu

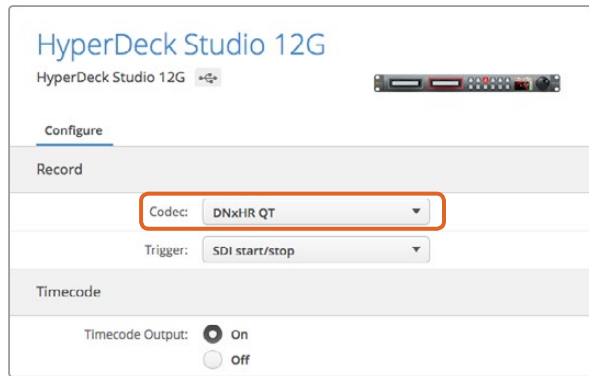

You can use the control panel LCD menu on HyperDeck Studio models, or use HyperDeck Setup to enable Start/Stop Recording.

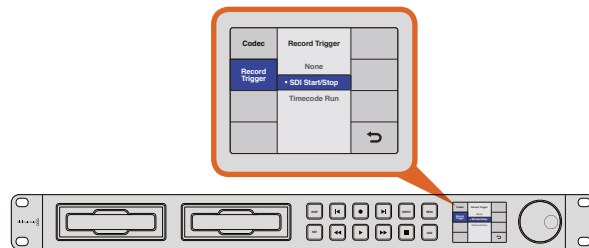

The 'record trigger' settings let you set your HyperDeck to start and stop recording triggered by data received over an HD-SDI connection.

SDI Start/Stop Recording

HyperDeck supports start/stop recording, which means when you press the record button on an HD-SDI camera, HyperDeck will start recording without also having to press the record button on your HyperDeck disk recorder.

To set up start/stop recording for supported cameras:

- Step 1.** You will need a camera that can trigger the record function of HyperDeck via HD-SDI. Cameras which support trigger recording via HD-SDI may include menu options such as 'trigger rec', HD-SDI remote I/F' or 'SDI remote start/stop trigger'.
- Step 2.** In HyperDeck Setup, set trigger recording to 'SDI start/stop'.
- Step 3.** If using HyperDeck Studio models, press the remote button which is marked REM on the control panel. The 'remote' button must be illuminated on the unit to allow trigger recording.

To set this on HyperDeck Studio models using the display menu:

- Step 1.** Press the 'disp' or 'menu' button to display the main menu.
- Step 2.** Scroll to the 'record' menu and press 'set'.
- Step 3.** Scroll to the 'record trigger' menu and press 'set'.
- Step 4.** Select 'SDI start/stop' and press 'set' to confirm your selection. Press 'disp/menu' to exit.
- Step 5.** Press the 'remote' button, which is the button marked as REM on the front panel. The remote button must be illuminated on the unit to allow trigger recording. When the remote button is enabled and illuminated, then the deck will accept remote control from the start/stop SDI command as well as other sources such as the RS-422 serial port and the timecode running if selected.

21 Control Panel Display Menu

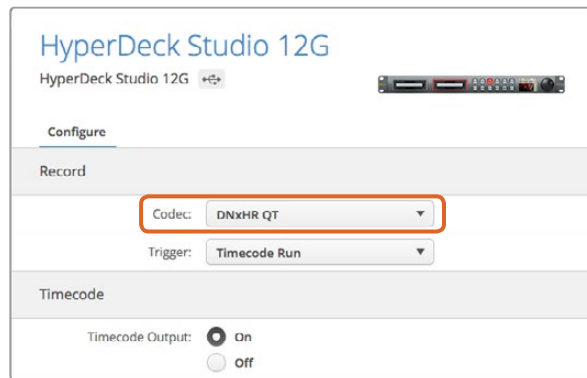

You can use the control panel LCD menu on HyperDeck Studio models, or use HyperDeck Setup to enable timecode run recording.

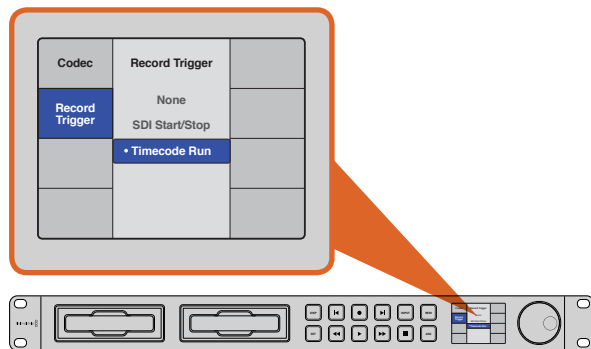

The 'Timecode run' recording feature lets you trigger your HyperDeck to record whenever running timecode is detected via the HD-SDI connection. Recording will stop when the timecode stops.

Timecode Run Recording

HyperDeck also supports timecode run recording, which is similar to start/stop recording, but is only used if your HD-SDI camera does not support trigger recording via HD-SDI.

To set up Timecode Run recording using HyperDeck Setup:

- Step 1.** Go into your camera's timecode settings and change them from 'free run timecode' to 'record run timecode'.
- Step 2.** In HyperDeck Setup, set trigger recording to 'timecode run'.
- Step 3.** On HyperDecks with a control panel, the remote button which is marked REM on the control panel. The 'remote' button must be illuminated on the unit to allow trigger recording.

To set up Timecode Run recording on HyperDeck Studio models using the display menu:

- Step 1.** Press the 'disp' or 'menu' button to display the main menu.
- Step 2.** Scroll to the 'record' menu and press 'set'.
- Step 3.** Scroll to the 'record trigger' menu and press 'set'.
- Step 4.** Select 'timecode run' and press 'set' to confirm your selection. Press 'disp' or 'menu' to exit.
- Step 5.** Press the 'remote' button. The 'remote' button must be illuminated on the unit to allow trigger recording.

Now whenever your HyperDeck detects the timecode running via HD-SDI it will start recording. Recording will stop whenever the timecode stops.

Be careful if your HyperDeck is connected to the SDI output of a video router, as any change to the video source might cause HyperDeck to start recording unexpectedly due to a change in timecode being detected via HD-SDI.

22 RS-422 Control

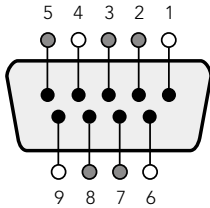

Receive (-)	Receive (+)	Transmit (-)	Transmit (+)	Ground Pins
2	7	8	3	1, 4, 6, 9

RS-422 remote pin connections.

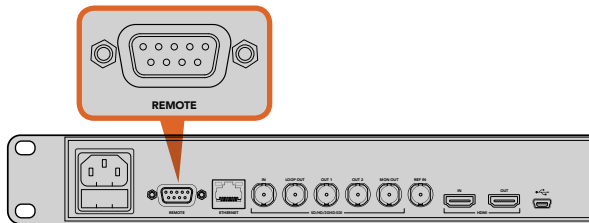

Remote port on HyperDeck Studio and HyperDeck Studio 12G.

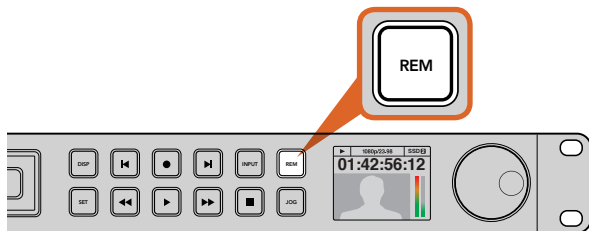

Press the remote button on HyperDeck Studio models to enable RS-422 deck control. The remote button is marked as REM on the front panel.

What is RS-422 Control?

The RS-422 standard is a serial deck control broadcast standard and has been used by broadcasters since the early 1980s and is found on many decks, linear editors, non linear editors and broadcast automation products. HyperDeck Studio models support this standard so can be integrated into broadcast automation, remote control systems, editing systems and any kind of custom control you might like to design yourself.

Using an External RS-422 Controller

All HyperDeck Studio models feature an industry standard Sony™ compatible RS-422 deck control port, which has the correct pin connections for a direct connection to any remote controller with RS-422.

You can use pre-manufactured 9 pin cables as long as each end of the cable is wired 'pin for pin' where the same pin numbers on each end of the cable are connected together. If you would like to make custom cables, please refer to the accompanying wiring diagram.

You can remotely control your HyperDeck Studio model from an RS-422 controller instead of locally pushing buttons.

- Step 1.** Connect a video signal to an SDI or HDMI video input of your HyperDeck Studio model.
- Step 2.** Connect an RS-422 cable from your external controller to your HyperDeck Studio model.
- Step 3.** Press the 'rem' button to enable remote deck control.

You can now remotely start and stop recording and playback of your HyperDeck Studio as well as performing other common jog and shuttle functions. The full list of supported RS-422 commands is in the following section named 'supported RS-422 commands'.

23 RS-422 Control

Supported RS-422 Commands

		Command	Reply	No Remote	Notes
0 - System Control					
0x00	0x11	DeviceTypeRequest	NTSC: 0xF0E0 PAL: 0xF1E0 24P: 0xF2E0	Enabled	
1 - Slave Response					
0x20	0x00	Stop	Acknowledge	Disabled	
0x20	0x01	Play	Acknowledge	Disabled	
0x20	0x02	Record	Acknowledge	Disabled	
0x20	0x10	FastFwd	Acknowledge	Disabled	
0x21	0x11	JogFwd1	Acknowledge	Disabled	
0x22	0x11	JogFwd2	Acknowledge	Disabled	Treated as N=1; Same as JogFwd1
0x21	0x12	VarFwd1	Acknowledge	Disabled	Uses ShuttleFwd1
0x22	0x12	VarFwd2	Acknowledge	Disabled	Treated as N=1; Same as VarFwd1
0x21	0x13	ShuttleFwd1	Acknowledge	Disabled	
0x22	0x13	ShuttleFwd2	Acknowledge	Disabled	Treated as N=1; Same as ShuttleFwd1
0x20	0x20	Rewind	Acknowledge	Disabled	
0x21	0x21	JogRev1	Acknowledge	Disabled	
0x22	0x21	JogRev2	Acknowledge	Disabled	Treated as N=1; Same as JogRev1
0x21	0x22	VarRev1	Acknowledge	Disabled	Uses ShuttleRev1
0x22	0x22	VarRev2	Acknowledge	Disabled	Treated as N=1; Same as VarRev1
0x21	0x23	ShuttleRev1	Acknowledge	Disabled	
0x22	0x23	ShuttleRev2	Acknowledge	Disabled	Treated as N=1; Same as ShuttleRev1
0x20	0x30	Preroll	Acknowledge	Disabled	
0x24	0x31	CueData	Acknowledge	Disabled	
0x20	0x34	SyncPlay	Acknowledge	Disabled	

24 RS-422 Control

Supported RS-422 Commands

		Command	Reply	No Remote	Notes
0x21	0x38	ProgSpeedPlayPlus	Acknowledge	Disabled	
0x21	0x39	ProgSpeedPlayMinus	Acknowledge	Disabled	
0x20	0x40	Preview	Acknowledge	Disabled	Status bits are set
0x20	0x41	Review	Acknowledge	Disabled	Status bits are set
0x20	0x43	OutpointPreview	Acknowledge	Disabled	
0x22	0x5C	DMCSetFwd	Acknowledge	Disabled	
0x22	0x5D	DMCSetRev	Acknowledge	Disabled	
0x20	0x60	FullEEOff	Acknowledge	Disabled	
0x20	0x61	FullEEOn	Acknowledge	Disabled	
0x20	0x63	SelectEEOn	Acknowledge	Disabled	
4 - Preset/Select Control					
0x40	0x10	InEntry	Acknowledge	Disabled	
0x22	0x23	ShuttleRev2	Acknowledge	Disabled	Treated as N=1; Same as ShuttleRev1
0x20	0x30	Preroll	Acknowledge	Disabled	
0x24	0x31	CueData	Acknowledge	Disabled	
0x20	0x34	SyncPlay	Acknowledge	Disabled	
0x21	0x38	ProgSpeedPlayPlus	Acknowledge	Disabled	
0x21	0x39	ProgSpeedPlayMinus	Acknowledge	Disabled	
0x40	0x11	OutEntry	Acknowledge	Disabled	
0x44	0x14	InDataPreset	Acknowledge	Disabled	
0x44	0x15	OutDataPreset	Acknowledge	Disabled	
0x40	0x18	InFwd	Acknowledge	Disabled	
0x40	0x19	InRev	Acknowledge	Disabled	
0x40	0x1A	OutFwd	Acknowledge	Disabled	
0x40	0x1B	OutRev	Acknowledge	Disabled	
0x40	0x20	InReset	Acknowledge	Disabled	
0x40	0x21	OutReset	Acknowledge	Disabled	
0x40	0x22	AlnReset	Acknowledge	Disabled	

Supported RS-422 Commands

		Command	Reply	No Remote	Notes
0x40	0x23	AOutReset	Acknowledge	Disabled	
0x44	0x31	PrerollPreset	Acknowledge	Disabled	
0x40	0x40	AutoModeOff	Acknowledge	Disabled	ignored, Status bit remembered
0x40	0x41	AutoModeOn	Acknowledge	Disabled	ignored, Status bit remembered
6 - Sense Request					
0x61	0x0A	TimeCodeGenSense			
		Request for Gen TC	GenTCData	Enabled	
		Timer1Sense	Timer1Data	Enabled	
		UserBitsVITCTimeSense	UserBitsVITCTimeData	Enabled	
		LTCUserBitsTimeSense	LTCUserBitsTimeData	Enabled	
		VITCUserBitsTimeSense	VITCUserBitsTimeData	Enabled	
0x60	0x10	InDataSense	InData	Enabled	
0x60	0x11	OutDataSense	OutData	Enabled	
0x60	0x12	AInDataSense	AInData	Enabled	
0x60	0x13	AOutDataSense	AOutData	Enabled	
0x61	0x20	StatusSense	StatusData	Enabled	
0x60	0x2E	SpeedSense	SpeedData	Enabled	
0x60	0x31	PrerollTimeSense	PreRollTimeData	Enabled	
0x60	0x36	TimerModeSense	TimerModeData	Enabled	
0x60	0x3E	RecordInhibitSense	RecordInhibitStatus	Enabled	

26 RS-422 Control

Supported RS-422 Commands

		Command	Reply	No Remote	Notes
7 - Sense Reply					
0x78	0x00	Timer1Data	-	-	Current Time and 00:00:00:00
0x78	0x04	LTCUserBitsTimeData	-	-	Current Time and 00:00:00:00
0x78	0x06	VITCUserBitsTimeData	-	-	Current Time and 00:00:00:00
0x74	0x06	VITCTimeData	-	-	Current Time
0x74	0x07	UserBitsVITCTimeData	-	-	00:00:00:00
0x74	0x08	GenTCData	-	-	Current Time
0x78	0x08	GenTCUBData	-	-	Current Time and 00:00:00:00
0x74	0x09	GenUBData	-	-	00:00:00:00
0x74	0x10	InData	-	-	
0x74	0x11	OutData	-	-	
0x74	0x12	AInData	-	-	
0x74	0x13	AOutData	-	-	
0x74	0x14	CorrectedLTCTimeData	-	-	Current Time
0x70	0x20	StatusData	-	-	Please see "Status Bits" sheet: Limited to 9 bytes of status, silently truncated
0x71	0x2E	SpeedData	-	-	
0x74	0x31	PrerollTimeData	-	-	
0x71	0x36	TimerModeData	-	-	Returns 0 (TimeCode)
0x72	0x3E	RecordInhibitStatus	-	-	

RS-422 Developer Information

	Bit 7	Bit 6	Bit 5	Bit 4	Bit 3	Bit 2	Bit 1	Bit 0
Byte 0	0	0	Cassette out	0	0	0	0	Local
Byte 1	Standby	0	Stop	0	Rewind	Forward	Record	Play
Byte 2	Servo Lock	0	Shuttle	Jog	Var	Direction	Still	1
Byte 3	Auto Mode	0	0	0	Aout Set	Ain Set	Out Set	In Set
Byte 4	Select EE	Full EE	0	0	0	0	0	0
Byte 5	0	0	0	0	0	0	0	0
Byte 6	0	Lamp Still	Lamp Fwd	Lamp Rev	0	0	0	0
Byte 7	0	0	0	0	0	0	0	0
Byte 8	0	0	Near EOT	EOT	0	0	0	0
Byte 9	0	0	0	0	0	0	0	0

Variables	
Cassette Out	Set if no SSD is present
Local	Set if Remote is disabled (local control)
Standby	Set if a disk is available
Direction	Clear if playback is forwarding, set if playback is reversing
Still	Set if playback is paused, or if in input preview mode
Auto Mode	Set if in Auto Mode
Select EE, Full EE	Set if in input preview mode
Lamp Still/Fwd/Rev	Set according to playback speed and direction
Near EOT	Set if total space left on available SSDs is less than 3 minutes
EOT	Set if total space left on available SSDs is less than 30 seconds

Others	
Cue Complete (byte 2, bit 0)	Always 1: Cue requests are always instantaneous

HyperDeck Serial RS-422 Protocol		
Protocol	Based on Sony 9-pin protocol	
Interface	Baud rate	38.4 kBits/s
	1 start bit	
	8 data bits	
	1 stop bit	
	1 parity bit	
	Odd parity	

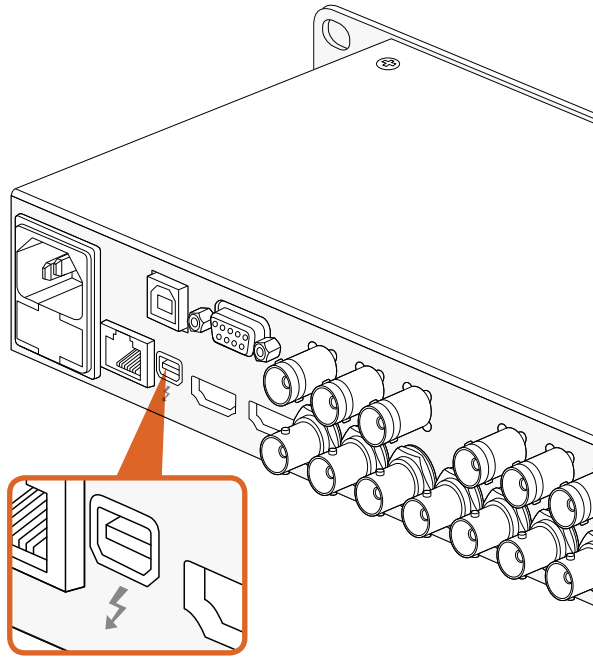

Capturing video via Thunderbolt

When connected to a computer with Thunderbolt technology, HyperDeck Studio Pro can be used as a powerful capture solution for your editing workflow. Thunderbolt offers a blazingly fast 10 Gb/s connection, which is enough bandwidth to handle the highest resolution video formats easily!

Capturing from SSD

If you want to dub a video that you've already recorded to SSD, you can capture via Thunderbolt using the video software and codec of your choice.

- Step 1.** Connect HyperDeck Studio Pro via a Thunderbolt cable to your computer.
- Step 2.** Launch your video capture software, such as Media Express, Adobe Premiere Pro, Apple Final Cut Pro 7 or AVID Media Composer.
- Step 3.** Make sure your software is configured to capture the same format as your source. e.g., 1080i50, 720p60.
- Step 4.** Press Play on HyperDeck Studio Pro. Video should appear on your computer screen within a few seconds.
- Step 5.** Click the capture button in your video software.

Simultaneous Capture and Recording

You can also simultaneously capture via Thunderbolt while recording to a SSD. This might be useful if you are recording a live event and are unsure if you have enough space on your SSDs to record the whole event. Alternatively, you may want to record in two different codecs, such as ProRes and DNxHD, simultaneously.

- Step 1.** Connect HyperDeck Studio Pro via a Thunderbolt cable to your computer.
- Step 2.** Launch your video capture software, such as Media Express, Adobe Premiere Pro, Apple Final Cut Pro 7 or AVID Media Composer.
- Step 3.** Make sure your software is configured to capture the same format as your source. e.g., 1080i50, 720p60.
- Step 4.** Press the INPUT button on HyperDeck Studio Pro to select the input from which you want to record to SSD and capture to your computer.
- Step 5.** Press Record on HyperDeck Studio Pro and click the capture button in your video software. You are now recording the same video input to both the SSD and to your computer.

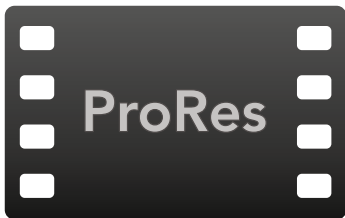

Accessing Your Clips

To access your clips, simply connect the SSD to your computer using an SSD dock. You can either drag the files from the SSD directly to a local hard drive, or you can work directly from the SSD. You can also connect the SSD to your computer with a 2.5" eSATA to USB cable adapter, however this won't be fast enough to handle working directly from the SSD and is really only recommended as a portable solution for getting your video files off the SSD and onto a laptop.

Mac OS X

QuickTime is built into Mac OS X. Apple ProRes, Avid DNxHD and DNxHR, and uncompressed QuickTime movies recorded by HyperDeck can be opened in almost any video software on Mac OS X.

DNxHD and DNxHR MXF files recorded by HyperDeck can be opened with Avid Media Composer and DaVinci Resolve for Mac.

MCC closed caption data files recorded by HyperDeck can be opened with MacCaption software for Mac OS X from <http://www.cpcweb.com>.

Windows

Apple ProRes and uncompressed QuickTime movies recorded by HyperDeck require QuickTime to be installed on your PC. Almost any video software on Windows that supports QuickTime can open movies recorded by HyperDeck. QuickTime for Windows can be downloaded free from <http://www.apple.com/quicktime/download/>.

DNxHD and DNxHR MXF files recorded by HyperDeck can be opened with Avid Media Composer and DaVinci Resolve for Windows.

MCC closed caption data files recorded by HyperDeck can be opened with CaptionMaker software for Windows from <http://www.cpcweb.com>.

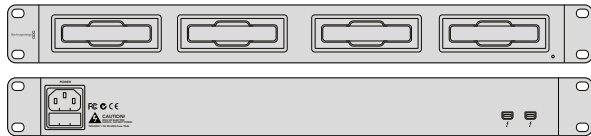

Blackmagic MultiDock is a fast and practical solution for your SSD post production workflow.

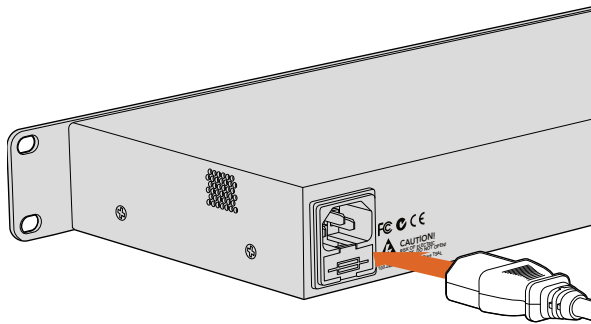

Connect your power supply to Blackmagic MultiDock using a standard IEC power cable and connector.

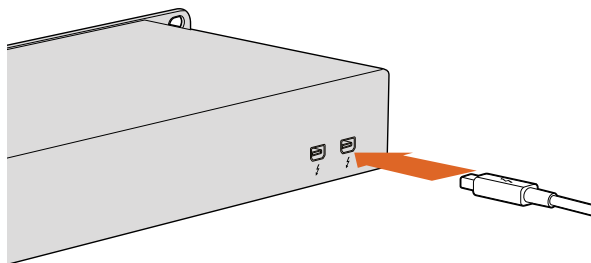

Connect Blackmagic MultiDock to your Mac or Windows PC using a Thunderbolt cable.

Using Blackmagic MultiDock with HyperDeck

Blackmagic MultiDock is an attractive rack mountable docking station and the perfect companion to HyperDeck and your SSD workflow.

After recording clips using HyperDeck, you can quickly and easily transfer the clip files to your computer, or another drive, with Blackmagic MultiDock using super fast 20Gb/s Thunderbolt 2 technology. Four drive bays each provide an independent, high performance SATA 3 disk interface so you can manage your files efficiently with no data bottlenecks, even when transferring large files using all four drives simultaneously!

If you want to, you can bypass the file transferring process and edit your clips directly from Blackmagic MultiDock, or stripe multiple drives as a RAID using your own operating system disk utility so you can maximize editing performance.

Blackmagic MultiDock is optimized for editing, color grading, or any job that requires large video files to be stored on multiple drives and provides options for you to make the most out of your SSD workflow. Blackmagic MultiDock can even use HDDs, or 'hard disk drives'.

Read the following pages to learn more about how you can use Blackmagic MultiDock with your HyperDeck SSD workflow.

Connecting to a Computer

Plug your power source into Blackmagic MultiDock's main power input using a standard IEC cable and connector. The power indicator on the front panel will illuminate when power is supplied.

Connect one end of a Thunderbolt cable to either of the Blackmagic MultiDocks's two Thunderbolt ports and connect the other end to a Thunderbolt port on your Mac or Windows PC. If your computer only has a single Thunderbolt port, you can use the additional Thunderbolt port on your MultiDock to attach a RAID or other device.

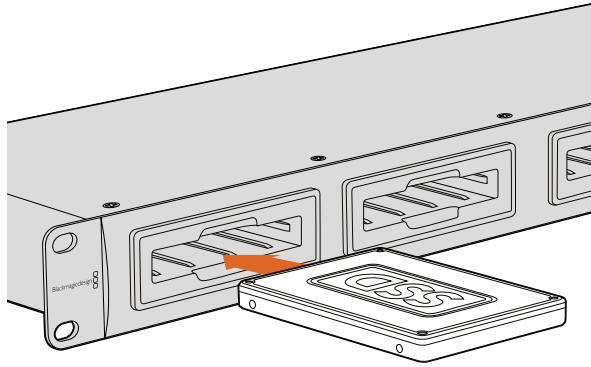

Plug SSDs or HDDs into any of Blackmagic MultiDock's 4 drive bays.

Plugging in Drives

Blackmagic MultiDock uses formatted 2.5" SSDs and HDDs.

To plug in your drive:

Step 1. Hold the drive so its gold SATA contacts are facing down and towards the drive bay.

Step 2. Gently push the drive into the drive bay until it slots into place.

The drive bay's red LED will briefly illuminate when a drive is detected. When an SSD or HDD is being read or written to, the drive bay's LED will flash according to the level of disk activity.

When plugging in formatted drives, they will be recognized by the computer and mounted.

On Mac OS X, drives will appear on the desktop.

On a Windows PC, drives can be found by clicking the 'start' icon, or 'start' page, and clicking on 'computer'. A window will open containing icons for all connected drives.

Identifying Drives

Blackmagic MultiDock has 4 independent drive bays. We recommend naming or renaming drives so they can be easily identified. Drives can be named when formatting using the 'disk utility' application on Mac OS X, or Windows Disk Management on Windows. Renaming a drive is as easy as right clicking on the drive in 'finder' or Windows Explorer. It's also helpful to physically label drives so they can be visually identified in each drive bay.

Formatting Drives

Blackmagic MultiDock can use any 2.5" SSD or HDD. New drives need to be formatted, or initialized, so a computer can read and write to the them. When working with Blackmagic cameras, drives will need to be formatted to either HFS+ or exFAT. These disk formats allow large file sizes and long video clips captured as single files.

HFS+

This format is also known as Mac OS Extended and is natively supported by Mac OS X. HFS+ supports journaling which means data is more likely to be recovered in the rare event an SSD or HDD is corrupted.

ExFAT

This format is supported natively by Mac OS X and Windows. ExFAT does not support journaling which means data is less likely to be recovered in the rare event an SSD or HDD is corrupted.

Drives can be formatted at any time, even if they already have data written on them. However, formatting a drive deletes all its data so anything important on a drive needs to be backed up before it is formatted.

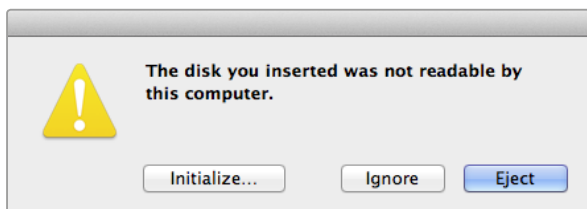

A new drive will need to be initialized so your computer can use it to read and write data.

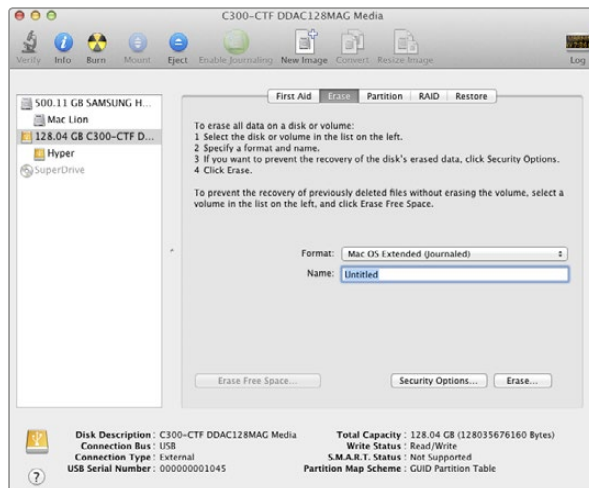

Use Disk Utility on Mac OS X to format or erase a drive in the Mac OS Extended (Journaled) or exFAT format.

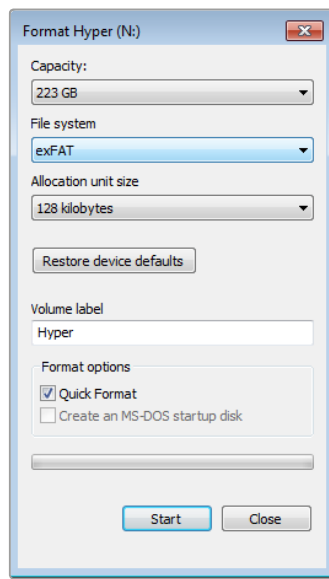

Drives can also be formatted in the exFAT format using the Format dialog box feature in Windows. It can be found by right clicking on the drive's icon.

Formatting Drives on Mac OS X

The 'disk utility' application included with Mac OS X can format a drive in the HFS+ or exFAT formats.

- Step 1.** Plug a new drive into Blackmagic MultiDock. A window will open asking to initialize the disk. Click 'initialize'.
- Step 2.** The 'disk utility' application will open. On the left of the window is a list of icons for all connected drives. Click on the disk icon for the new drive.
- Step 3.** Select the 'erase' tab in the top menu.
- Step 4.** Set the format to 'Mac OS Extended (Journaled)' or 'exFAT'.
- Step 5.** Type a name for the new volume and then click 'erase'. Click 'erase' again to confirm the selection. The new drive will quickly be formatted and made ready for use with Blackmagic MultiDock.

Formatting Drives on Windows

Windows uses the 'disk management' application to format a new drive in the exFAT format.

- Step 1.** Plug a new drive into Blackmagic MultiDock.
- Step 2.** Go to: control panel/administrative tools/computer management/storage/disk management.
- Step 3.** Right click on the new drive from the list of connected drives and select 'new simple volume'. New unformatted drives will be described as 'unallocated'.
- Step 4.** A window will open asking for the volume size. Leave the volume size defaulted to the drive's maximum capacity. Click 'next'.
- Step 5.** Assign a drive letter and click 'next'.
- Step 6.** Set the file system to 'exFAT'. Type a volume label, select 'quick format' and click 'next'. The new drive will be quickly formatted and made ready for use with Blackmagic MultiDock.

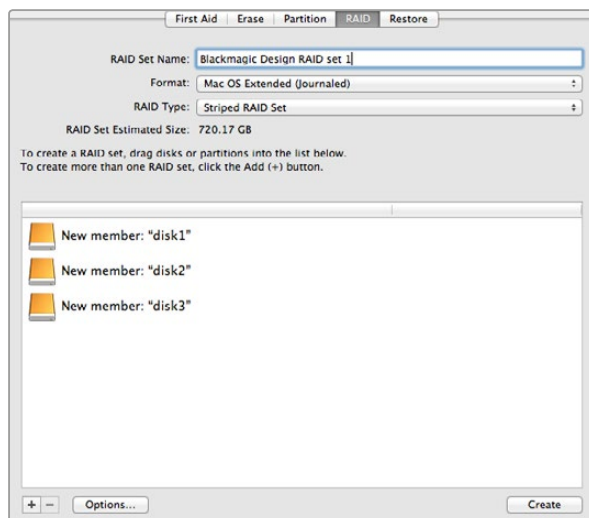

3 SSDs being striped as a level 0 RAID using Disk Utility on Mac OS X.

Setting up a RAID for High Speed Performance and Data Security

Blackmagic MultiDock supports 2 levels of RAID, or redundant array of independent disks. RAID level 0 stripes drives together so they are recognized by a computer as one single drive to increase performance. RAID level 1 configures two drives so one is always mirrored by the other, which increases data security.

Striping drives as a RAID shares data over a set of drives which requires careful management. It's also worth noting that if striping drives as a RAID, stripe only a set of SSDs or a set of HDDs, not a combination of both.

RAID Level 0 for High Speed Performance

When using HDDs for uncompressed video capture and playback, it's beneficial to stripe 2 to 4 drives together as a RAID. Sharing the data amongst a pair of drives doubles the total capacity, plus decreases their workload, so you get faster performance. Similarly, configuring 3 or 4 drives as a RAID level 0 triples or quadruples their total drive capacity. For example, a computer will recognize 4 x 1 terabyte drives striped using level 0 RAID as 1 single 4 terabyte drive.

When drives are striped together in a RAID set, be careful not to unplug any of the drives while the computer is powered, otherwise data may be lost. When using RAID, shut down the computer before removing or swapping drives.

SSDs can also be striped together as a level 0 RAID, however, performance increases are generally limited to workflows using large sequential files, such as reading and writing Ultra HD or uncompressed video files. For general every day tasks, the performance increase is negligible so single SSDs should probably be used.

When detecting drives, Blackmagic MultiDock looks for drive names, therefore a set of drives configured as a RAID can be plugged into any of Blackmagic MultiDock's 4 drive bays.

RAID Level 1 for Data Security

Blackmagic MultiDock has 4 drive bays which can be configured as 2 pairs of mirrored SSDs or HDDs. A mirrored pair of drives are recognized as one single drive. Using RAID level 1 gives an immediate back up as data is written to the drive. If one drive fails, the other is instantly available.

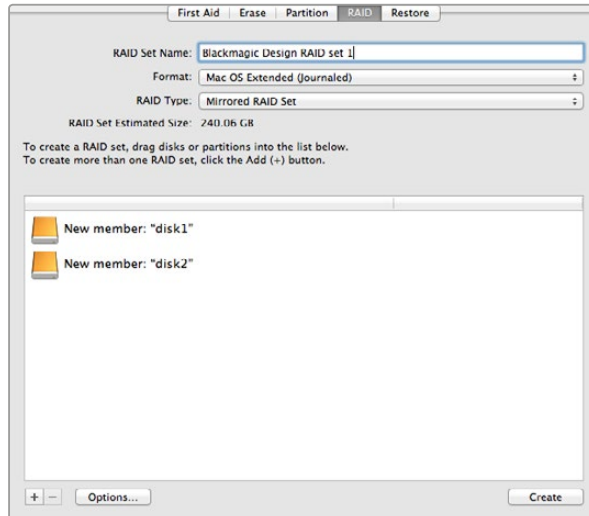

2 SSDs being mirrored as a RAID level 1 using Disk Utility on Mac OS X.

Configuring a RAID using Mac OS X and Windows

To configure a RAID, use the 'disk utility' application for MAC OS X or 'window disk management' for Windows.

The 'Mac OS X disk utility' application can be found by clicking 'go' on the desktop menu bar, then selecting 'utilities' or 'disk utilities'. 'Windows disk management' can be opened by clicking the control panel, then selecting 'administrative tools'/'computer management'/'storage'/'disk management'.

For detailed information on how to configure a RAID, refer to your operating system's online support.

Unplugging your Drives

Make sure drives have been properly ejected before removing them from their drive bays. HDDs have longer initialize and shut down times compared to SSDs. This is because HDDs use spinning discs to store data which take time to reach speed.

Ejecting a drive on Mac OS X

Right click on the drive icon on the desktop and select 'eject'. Blackmagic MultiDock's drive bay LED will flash briefly and the drive will disappear from the desktop. The drive is now ready to be unplugged from Blackmagic MultiDock.

Ejecting a drive on a Windows PC

Click on the 'safely remove hardware' and 'eject media' icon at the bottom right of the desktop. A list of drives and devices will appear above the icon. Click on the drive to eject. Blackmagic MultiDock's drive bay LED will flash briefly, and the drive will disappear from the device list on the desktop. The drive is now ready to be unplugged from Blackmagic MultiDock.

NOTE: When using a RAID, it's important to shut down the computer before unplugging the RAID set. Never unplug a drive from a RAID set while the computer is operating or there will be a risk of data loss.

35 Using DaVinci Resolve



Introducing DaVinci Resolve

Recording clips using Blackmagic HyperDeck is only part of the process of creating film and television content, and just as important is the process of media backup and management as well as editing, color correction and encoding final master files. Using DaVinci Resolve you have a complete solution for recording and post production! DaVinci Resolve can be downloaded for free from our web site for use with the files recorded with your HyperDeck and provides powerful color correction and editing.

After connecting your SSD card to your computer, you can use DaVinci Resolve's 'clone' tool, in the 'media' page, to create running backups of your recorded clips. This is recommended as any type of media is susceptible to becoming damaged or developing a fault so creating backups ensures your clips will be immune to loss. Once you have used DaVinci Resolve to back up your media, you can then add your clips to the DaVinci media pool, then edit, color correct, and finish your production without ever having to leave DaVinci Resolve.

DaVinci Resolve will help you adjust your clips to get any kind of look you are after. DaVinci Resolve is the same tool used on most major blockbuster movies, so it's much more than a simple NLE software tool, as it has extremely advanced technology built in for high end digital film. You get the advantage of this technology when you use DaVinci Resolve to edit and color correct your work.

Included here is information on how to get started using DaVinci Resolve with your HyperDeck recorded SSD files. Of course, DaVinci Resolve is extremely advanced and includes a lot more features than you immediately see when first looking at its user interface. To learn more about how to use DaVinci Resolve, please download the DaVinci Resolve instruction manual pdf file from the Blackmagic Design Support Center on the Blackmagic Design website, or check online for the many training courses and tutorial videos available.



To import your clips, simply drag them from the 'media storage' browser and drop them into the media pool. You can also drag and drop files from your desktop.

Importing your Clips

To start editing your clips, you'll first need to import them into the media pool:

- Step 1.** Launch DaVinci Resolve. If this is the first time you've opened DaVinci Resolve, wait for the Project Manager to appear, and double click the 'untitled project' icon in the project manager window. If the log in window appears, that means you have the Resolve multi-user environment enabled. In this case, click Add New at the bottom left of the log in window and create a new user by entering a user name and clicking Setup New User. Then double-click the user icon to proceed to the Project Manager.
- Step 2.** You'll now see the 'media' page with a 'media storage' browser at the top left. The 'media storage' browser displays all your linked media folders from where you'll drag your clips and drop them into the media pool.

36 Using DaVinci Resolve

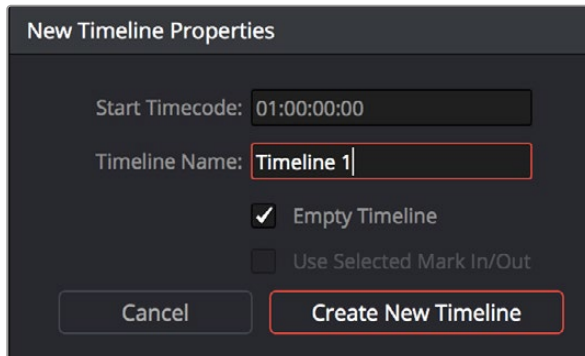

To start editing your clips, you'll need to create a new timeline. The timeline is the stage upon which all your editing will take place.



The 'edit' page. You can trim your clips, change their order, move them around and add transitions between them using the timeline editor.

If your clip folder doesn't appear in the library, you'll need to add it. This is easily done by clicking on preferences in the DaVinci Resolve title bar and clicking on the 'plus' icon in the 'media storage' tab, browse to and select a drive or folder path, click 'save', restart DaVinci Resolve and reopen 'untitled project' to refresh the 'media storage' settings.

- Step 3.** In the 'media storage' browser, click on your newly added clip folder. Now simply drag your clips from your storage folder and drop them into the media pool. If the untitled project settings are different to your clip settings, you'll be prompted to either change the project settings to match your clips, or leave the settings as they are. To get started quickly, click 'change'. Now your project settings match your clips.

Editing your Clips

With your clips in the media pool, click on the 'edit' tab to open the edit page.

Now you can start building your edit!

- Step 1.** You'll first need to create a new timeline. Right click anywhere within the media pool and choose Timelines > Create New Timeline. When the dialog box appears, click the 'create new timeline' button.
- Step 2.** Click on the 'media pool' button above the timelines window. Now double click on a clip to open the clip in the source viewer. Use the mouse pointer to scrub the play head in the source viewer left and right until you find the start frame you want for the clip. Mark the in point with the 'I' shortcut. Do the same for the end frame using the 'O' shortcut.
- Step 3.** Go to the timeline and position the timeline play head where you want your clip to be inserted.
- Step 4.** To insert the clip onto the timeline, click inside the source viewer then drag the mouse pointer across to the timeline viewer. A list of edit options will appear. Select the type of edit you want.

Your clip will be placed onto the timeline using the edit type you selected. You'll find a description of each edit type and how to use them in the DaVinci Resolve manual.

A faster way to add clips to your edit is by dragging them from the media pool and dropping them directly onto the timeline where you can adjust your in and out points, position your clips, try different plug in effects, titles, and more. This particular workflow is like using the timeline as an artist's palette.



Trim your clips by dragging their start and end points left or right. The 'snapping' feature can be turned off when making fine adjustments.

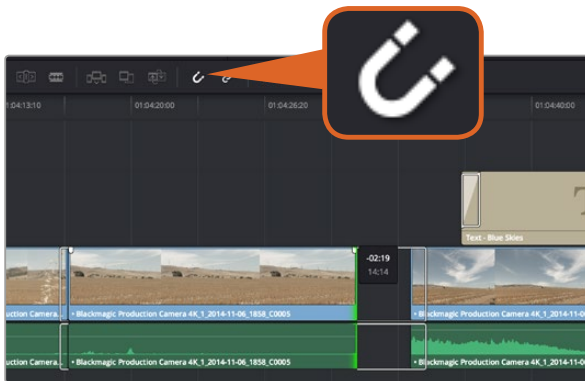

Trim your clips by dragging their start and end points left or right. The 'snapping' feature can be turned off when making fine adjustments.

Trimming Clips

When editing clips you'll want to trim them to include only the specific actions you want in each shot. There are various ways, but the easiest is to adjust the clips' in and out points on the timeline:

- Step 1.** After adding clips to your timeline, hover your mouse pointer over the start of a clip until the pointer becomes a 'trim' icon.
- Step 2.** When the 'trim' icon appears, click on the start of your clip and drag it forwards or backwards to trim the in point. Watch the timeline monitor as you trim to find the edit point.
- Step 3.** Now click and drag the end of your clip to adjust the out point.

The zoom slider is located above the timeline, to the left of the tools that are centered in the toolbar. By dragging the slider left and right you can zoom in and out of your timeline to make fine adjustments.

Turning the 'snapping' feature off is handy when fine tuning edits, but it's a helpful feature to keep your clips held tightly against each other, so it's worth turning back on once you're done. Press the 'N' key to quickly turn snapping on or off.

Mapping Keyboard Shortcuts

If you are familiar with keyboard shortcuts using other editing software, you can easily map your own in DaVinci Resolve to increase speed and optimise your workflow.

To map your own keyboard shortcuts:

- Step 1.** Click on the project setting 'gear' icon at the bottom right of your DaVinci workspace, then select 'keyboard mapping' from the settings list.
- Step 2.** Select the shortcut you want to change from the categories provided, for example timeline cut and paste shortcuts will be in the 'edit' category.
- Step 3.** Click on the shortcut once to highlight the setting. Double click on the shortcut to enable the change.
- Step 4.** Press your new shortcut keys on the keyboard. If you make a mistake you can easily undo the change by clicking the 'undo' icon next to the setting.
- Step 5.** Click 'save' to confirm your new shortcut setting.

38 Using DaVinci Resolve

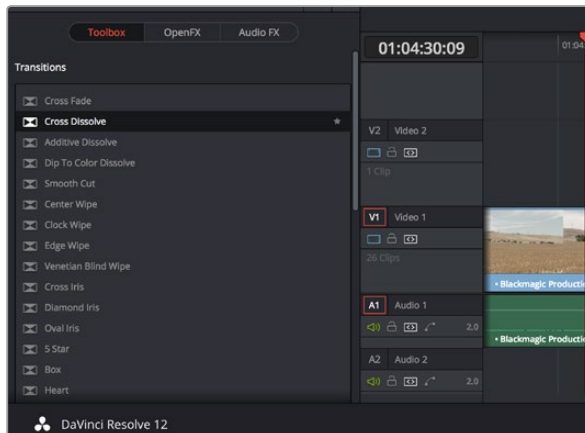

The transitions palette contains many types of transition effects.

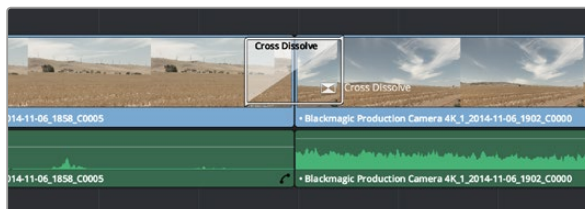

Simply drag and drop transitions between adjoining clips.



Drag a title type from the 'titles' palette and drop it on an empty track.

Adding Transitions

A transition is a visual effect used to bridge one clip to another in a pleasing way, for example dissolves, wipes, dips to color, and more. These can add a layer of excitement to your edit. Transitions don't always have to be joining two clips, for example you can apply a dissolve transition to the end of one clip to create a quick and easy fade to black.

To add a dissolve transition between two clips:

- Step 1.** Make sure there are two clips edited right next to one another on the timeline. Click the 'effects library' button in the UI toolbar at the top of the 'edit' page, and make sure the 'toolbox' panel is open.
- Step 2.** Click on the 'cross dissolve' transition, drag it to your timeline and hover it over the edit point between two clips. You'll see the mouse pointer highlight both the end section of the first clip, and the start of the second. Drop the transition onto the clips. It's important both clips have enough length before and after their edit points to make room for the dissolve.

You now have a smooth transition mixing from one clip to the other. If you want to adjust the length of the transition you can lengthen or shorten its start and end point using a similar approach to trimming a clip. Hover your mouse pointer over the start or end of the transition until the transition 'trim' icon appears, then drag it left or right.

Adding Titles

It's easy to create titles for your edit. You can place a title on any video track just as you would a clip. If you run out of tracks you can easily add new ones by right clicking next to an existing track name and selecting 'add track'.

To create a title:

- Step 1.** Scroll down towards the middle of the toolbox in the 'effects library' located underneath the media pool and you'll see the 'titles' generators. Use the scroll bar to reveal more 'titles' options.
- Step 2.** Drag and drop a text title on the empty video track above the clip you want the title to appear. You can even drop your title next to a clip on Video 1 if you just want it to appear over black. To see the title, make sure the timeline playhead is on the title.
- Step 3.** Double click on the title clip. The 'inspector' will appear showing you the settings for your title. Type your title into the 'text' field.

You can choose from a variety of fonts and adjust the appearance of your title by changing settings

39 Using DaVinci Resolve

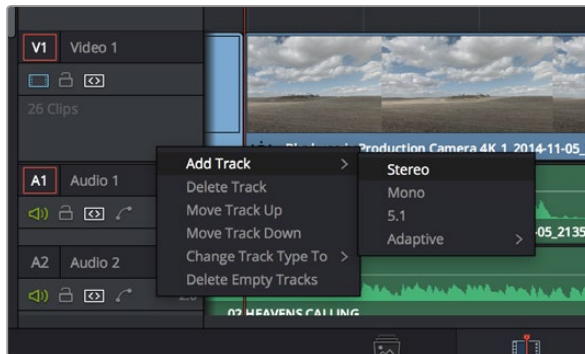

To add a new audio or video track, right click next to a track name and select 'add track'. For audio, select the track type you want.



With the 'color' page you get absolute control over the look of your clips.

such as color, size, alignment, position, and more. Transitions can be added to titles, just like they can for clips.

Adding Audio Tracks

If you want to mix a large sound edit with lots of sound effects and music, you can easily add more audio tracks when you need them.

To add an audio track:

Step 1. Right click next to the name of the last audio track on your timeline and select 'add track'.

Step 2. Select the type of audio track you want, such as stereo, mono, 5.1 or adaptive.

Your new audio track will appear on the timeline.

This can be handy when you want to separate your audio elements into individual tracks for a sound mix, for example voice, sound effects, and music.

Refer to the DaVinci Resolve manual for more information on how you can use all the powerful editing tools.

Color Correcting your Clips

Once you have edited your sequence of clips, you can start color correcting. This is best begun after you have finished editing your sequence so you can maintain a consistent look, but part of the fun of DaVinci Resolve is being able to move between the edit and color page to make fine adjustments and discover new creative choices.

First, click on the 'color' tab to open the 'color' page.

You'll see the color wheels, curves palettes and general color correction tools as well as the preview and nodes window. Don't feel overwhelmed by the vast array of features in front of you, they are all there to help you get the most amazing looking pictures. The DaVinci Resolve manual will show you exactly what the tools are for and how to use them in easy to follow steps. You'll learn the same techniques the professionals use in high end color correction facilities.

Generally, the first thing you'll want do is optimize the shadows, mid tones and highlights in your clips. In other words adjust the 'lift', 'gamma' and 'gain' settings. This will help get your pictures looking their brightest and best with a clean, uniform starting point from where you can begin grading the 'look' of your film.

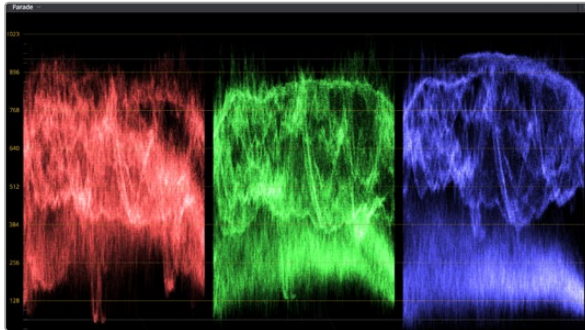

The parade scope helps you optimize highlights, mid tones and shadows.



The 'lift', 'gamma', 'gain' and 'offset' and offset color wheels give you total control over the color and tonal balance of your clips. To make a uniform adjustment to all colors for each tonal region, drag the dial underneath the color wheels back and forth.

Using Scopes

Most colorists make creative color choices by focusing on the emotion and the look they want their program to have and then simply work using the monitor to achieve that look. You can look at everyday objects and how different types of light interact with them to generate ideas on what you can do with your images and a little practice.

Another way to color grade is to use the built in scopes to help you balance shots. You can open a single video scope by clicking the 'scope' button, which is the second from the right on the palette toolbar. You can choose to display a waveform, parade, vectorscope and histogram. Using these scopes you can monitor your tonal balance, check the levels of your video to avoid crushing your blacks and clipping the highlights, plus monitor any color cast in your clips.

By default, the 'color wheels' palette, which contains the 'lift', 'gamma' and 'gain' controls which will generally constitute your first adjustment, is set to display the 'primaries bars'. You can change this to display the 'primaries wheels' using the 'mode' pop-up menu at the upper-right-hand corner of the palette. These should resemble controls you've seen in other applications for doing color and contrast adjustments.

Step 1. Adjusting the 'lift'

With your first clip selected on the color timeline, click on the 'lift' dial underneath the first color wheel. Slide it back and forth and watch how it affects your image. You'll see the brightness of the dark regions of your picture increase and decrease. Set it to where you want the dark areas to look their best. If you decrease the lift too much, you'll lose details in the blacks and you can use the parade scope to help avoid this. The optimal position for blacks on the waveform is just above the bottom line of the parade scope.

Step 2. Adjusting the 'gain'

Click on the 'gain' dial and slide it back and forth. This adjusts the highlights which are the brightest areas of your clip. The highlights are shown on the top section of the waveform on the parade scope. For a brightly lit shot, these are best positioned just below the top line of the waveform scope. If the highlights rise above the top line of the waveform scope, they will clip and you will lose details in the brightest regions of your image.

Step 3. Adjusting the 'gamma'

Click on the 'gamma' dial underneath the color wheel and slide it back and forth. As you increase the gamma you'll see the brightness of the image increase. Notice the middle section of the waveform will also move as you adjust the gamma. This represents the mid tones of your clip. The optimal position for mid tones generally falls between 50 to 70% on the waveform scope. However, this can be subjective based on the look you are creating and the lighting conditions in the clip.

41 Using DaVinci Resolve

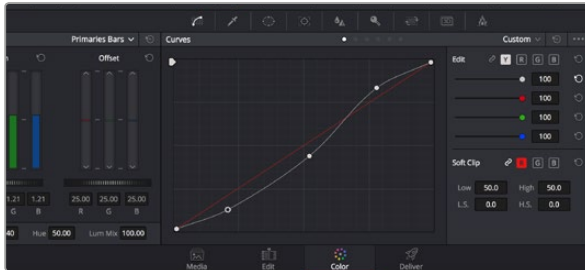

The curves palette is another tool you can use to make primary color corrections, or enhance specific areas of your clip when using a power window.



Use the HSL qualifier feature to select specific colors in your image. This is handy when you want to make areas of your image 'pop', to add contrast, or to help draw the audience's attention to certain areas of your shot.

You can also use the curves palette to make primary color corrections. Simply click to create control points on the diagonal line inside the curve graph, and drag them up or down to adjust the master RGB contrast at different areas of image tonality. The optimum points to adjust are the bottom third, mid, and top third of the curve line.

There are many more ways of doing primary color correction in DaVinci Resolve. Check the DaVinci Resolve manual to learn how to use them all.

Secondary Color Correction

If you want to adjust a specific part of your image then you need to use secondary corrections. The adjustments you have been doing up until now using the color wheels and lift, gamma and gain adjustments affect the whole image at the same time and so they are called primary color corrections.

However if you need to adjust specific parts of your image, say for example you wanted to improve the color in the grass in a scene, or you wanted to deepen the blue in a sky, then you can use secondary corrections. Secondary color corrections are where you select a part of the image and then adjust just that part. With nodes, you can stack multiple secondary corrections so you can keep working parts of your image until everything is just right! You can even use windows and tracking to allow the selections to follow movement in your images.

Qualifying a Color

Often you'll find a specific color in your clip can be enhanced, for example grass by the side of a road, or the blue in a sky, or you may need to adjust color on a specific object to focus the audience's attention on it. You can easily do this by using the HSL qualifier tool.

To qualify a color:

- Step 1.** Add a new serial node.
- Step 2.** Open the 'qualifier' palette and make sure the 'color range' sample eyedropper tool is selected.
- Step 3.** Click on the color in your clip you want to affect.
- Step 4.** Adjust the 'width' control in the 'hue' window to broaden or narrow your selection.

Usually you'll need to make some adjustments to soften the edges of your selection and limit the region to only the desired color. Click on the 'highlight' button to see your selection.

42 Using DaVinci Resolve



Use power windows to mask out areas you don't want to be affected by the HSL qualifier secondary adjustments.



Power windows let you make secondary corrections to specific parts of your image.

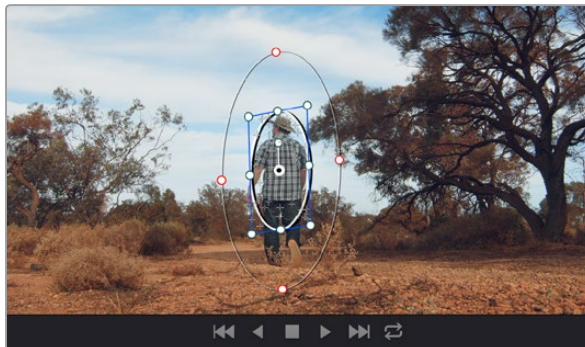

You can track objects or areas in your clip using the tracker feature so power windows can follow the action.

Sometimes your selection can spill into areas of the shot you don't want to affect. You can easily mask out the unwanted areas using a power window. Simply create a new window and shape it to select only the area of color you want. If your selected color moves in the shot, you can use the tracking feature to track your power window.

Adding a Power Window

Power windows are an extremely effective secondary color correction tool that can be used to isolate specific regions of your clips. These regions don't have to be static, but can be tracked to move with a camera pan, tilt or rotation, plus the movement of the region itself. For example, you can track a window on a person in order to make color and contrast changes just to that person without affecting his/her surroundings. By making corrections like this you can influence the audience's attention on areas you want them to look at.

To add a power window to your clip:

- Step 1.** Add a new serial node.
- Step 2.** Open the 'window' palette and select a window shape by clicking on the icon next to the shape. Your selected window shape will appear on the node.
- Step 3.** Resize the shape by clicking and dragging the blue points around the shape. The pink points adjust the edge softness. You can position the shape by clicking the center point and moving it to the area you want to isolate. Rotate the window using the point connected to the center.

Now you can make color corrections to your image in just the area you want.

Tracking a Window

The camera, object or area in your shot may be moving, so to make sure your window stays on your selected object or area, you'll need to use DaVinci Resolve's powerful tracking feature. The tracker analyzes the pan, tilt, zoom and rotation of the camera or object in your clip so you can match your windows to that movement. If this isn't done, your correction can move off the selected target and call attention to itself, which you probably don't want.

To track a window to a moving object:

- Step 1.** Create a new serial node and add a power window.
- Step 2.** Go to the start of your clip and position and size the window to highlight just the object or area you want.

43 Using DaVinci Resolve

Step 3. Open the 'tracker' palette. Select the pan, tilt, zoom, rotate, and perspective 3D settings appropriate for the movement in your clip by checking or unchecking the relevant 'analyse' checkboxes.

Step 4. Click on the 'forward' arrow to the left of the checkboxes. DaVinci Resolve will now apply a cluster of tracking points on your clip and then step through the frames to analyze the movement. When the tracking is done, your power window will follow the path of the movement in your clip.

Most of the time automatic tracking is successful, but scenes can be complex and sometimes an object can pass in front of your selected area, interrupting or affecting your track. This can be solved manually using the keyframe editor. Refer to the DaVinci Resolve manual to find out more.

Using Plugins

While making secondary color corrections you can also add OpenFX plugins to create fast, interesting looks and effects using the 'color' page, or imaginative transitions and effects on your clips on the 'edit' page. OFX plugins can be purchased and downloaded from third party suppliers.

After installing a set of plugins, you can access them on the color page by opening the OpenFX inspector to the right of the 'node editor'. Simply click the 'OpenFX' button to open the OpenFX inspector, create a new serial node and drag and drop a plugin onto the new node. If the plugin has editable settings, you can adjust these in the adjoining 'settings' panel.

In the 'edit' page you can add plugin generators and transitions to clips by opening the 'OpenFX' panel in the 'effects library' and dragging your selected plugin onto your clip on the timeline.

Mastering your Edit

So now you've edited, color corrected and graded your clips you'll want to export a render of your edit in the 'deliver' page. This page lets you select the range of clips you want to export, plus the format, codec and resolution you want. You can export in many types of formats such as QuickTime, AVI, MXF and DPX using codecs such as 8-bit or 10-bit uncompressed RGB/YUV, ProRes, DNxHD, H.264 and more.

To export a single clip of your edit:

Step 1. Click on the 'deliver' tab to open the deliver page.

Step 2. Go to the 'render settings' window on the top left of the page. In the 'format' settings, select 'single clip'. Choose a video format and codec, and resolution. The frame rate will usually be locked to the project settings frame rate. If you want to include audio with your export, tick the 'export audio' checkbox in the 'audio' settings.



OFX plugins are a quick and easy way to create imaginative and interesting looks.



The 'deliver' page is where you export your edit. You can select from many different video formats and codecs.

44 Using DaVinci Resolve

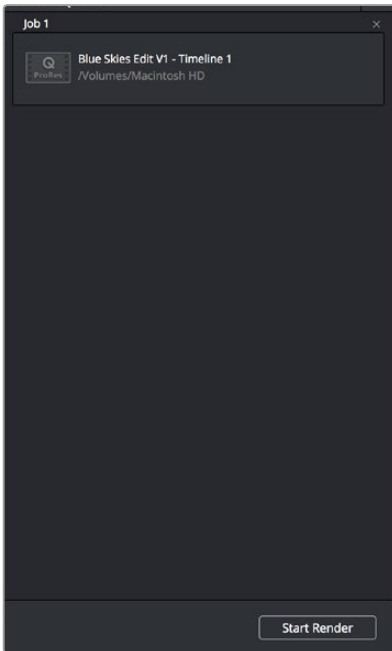

After adding your render settings to the render queue, click the 'start render' button to export your edit.

- Step 3.** In the 'file' settings, select 'use custom filename'. Name your export, then choose your destination by clicking the 'browse' button and selecting a folder location. Click 'ok'.
- Step 4.** You'll see the 'deliver timeline' stretched across the bottom of the page. Select 'all clips' to select the entire program for rendering.
- Step 5.** Go to the bottom of the 'render settings' and click on the 'add job to render queue' button. Your render settings will be added to the render queue on the right side of the page. Now all you have to do is click 'start render' and monitor the progress of your render in the render queue.

When your render is complete you can open the folder location, double click on your new rendered clip and watch your finished edit.

45 Using Third Party Editing Software



Media Composer

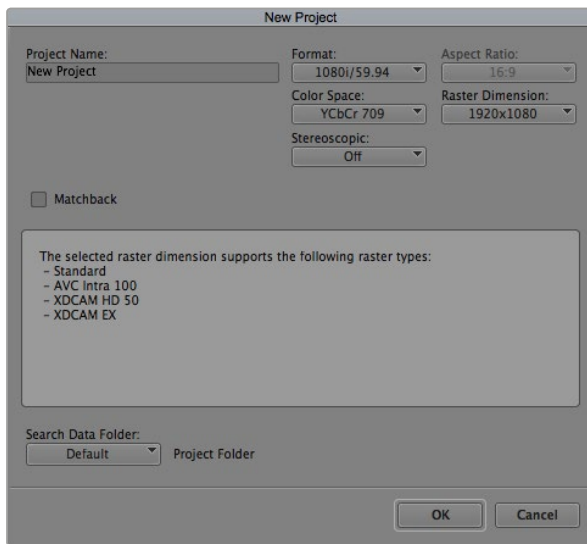

Step 5. Type a project name and set the project options.

Avid Media Composer

Avid Media Composer captures standard and high definition video live from HyperDeck Studio Pro via a Thunderbolt cable. When you install the HyperDeck Software, Blackmagic plug-ins are automatically installed to Media Composer.

You can use the INPUT button on HyperDeck Studio Pro to select your video and audio connections including SDI, HDMI and analog.

HyperDeck Setup also installs a HyperDeck Studio deck preset to help with RS-422 deck control.

Setting up

- Step 1.** Launch Media Composer and the Select Project dialog box will appear.
- Step 2.** Choose your preferred User Profile if you have previously created one.
- Step 3.** Select the folder in which you want to create the project: Private, Shared or External.
- Step 4.** Click the New Project button.
- Step 5.** Type a project name and set the project options including Format and Color Space. Click OK. Once the project has been created, the frame rate and raster cannot be changed. The color space setting can be changed later in the Format tab of the project.
- Step 6.** Double-click the project name in the Select Project dialog box. The Media Composer interface will appear along with the project window for your new project. You have completed setting up your project.

46 Using Third Party Editing Software

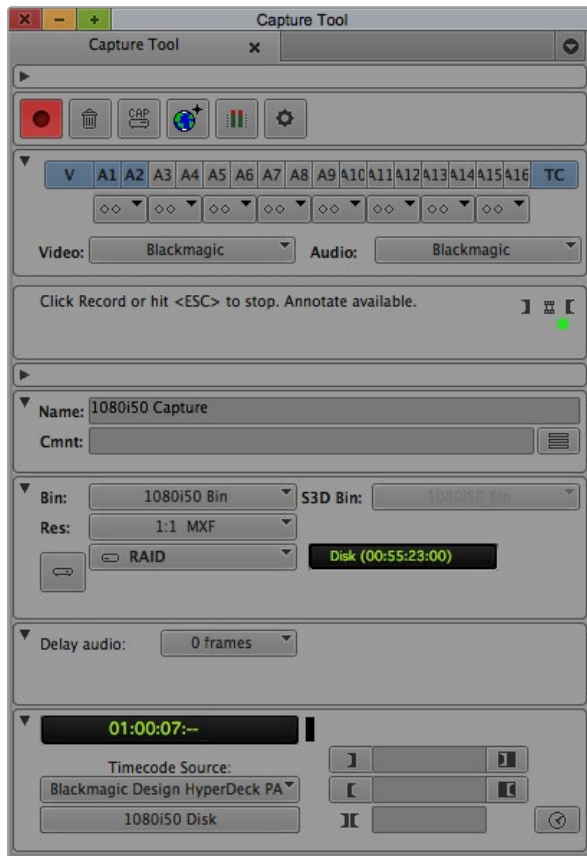

Step 2. Set up the Capture Tool to capture video by clicking the Toggle Source button.

Capturing live via Thunderbolt

To capture video live via Thunderbolt from HyperDeck Studio Pro:

- Step 1.** Choose Tools > Capture to open the Capture Tool.
- Step 2.** Set up the Capture Tool to capture video by clicking the Toggle Source button.
- Step 3.** Set the Video and Audio input menus to "Blackmagic".
- Step 4.** Select the video source track (V) and the audio source tracks (A1, A2, ...) you wish to capture.
- Step 5.** Use the Bin menu to select a Target Bin from the list of open bins.
- Step 6.** From the Res (resolution) menu, choose which compressed or uncompressed codec you wish to use for your captured clips. For maximum quality uncompressed video, choose "1:1" for 8-bit video capture or "1:1 10b" for 10-Bit video capture.
- Step 7.** Select the disk storage for your captured video and audio. Use the Single/Dual Drive Mode button to determine if video and audio will be stored together on a single drive or video on one drive and audio on another drive. Select the target drive(s) for your captured media from the Target Drives menu(s).
- Step 8.** Click the "Tape Name?" button at the bottom of the window to open the Select Tape dialog box. Select the desired tape, or add a new one, and then click OK.
- Step 9.** Ensure your video and audio source is ready or playing and then click the Capture button or press the F4 key. The Capture button will flash red while recording. Click the Capture button again or press the Escape button on your keyboard to end the capture.

If you can't see an image in your video capture window:

- Step 1.** Quit Media Composer.
- Step 2.** Launch Blackmagic UltraScope. Note the output video standard that is displayed on the left side of UltraScope's Picture Display. Quit UltraScope.
- Step 3.** Launch Media Composer and set the project preferences to match the standard reported by UltraScope.



Final Cut Pro 7

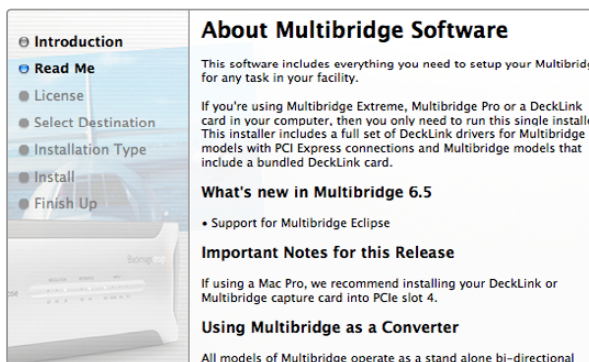

Select a Blackmagic Easy Setup

Apple Final Cut Pro 7

When you install the HyperDeck Software, Blackmagic Easy Setups are automatically installed to Final Cut Pro 7.

Setting up

- Step 1.** Launch Final Cut Pro 7 and the Easy Setup window will appear.
- Step 2.** Click on the popup menu and select the desired Blackmagic Easy Setup. For each video format (NTSC, PAL and HDTV) you will find a range of Blackmagic compressed and uncompressed file formats you can choose.
- Step 3.** Click on the popup menu named Primary Scratch Disk and select your disk array from the popup menu.
- Step 4.** Click OK and the Final Cut Pro interface will appear.

Capturing live via Thunderbolt

To capture video live via Thunderbolt from HyperDeck Studio Pro:

- Step 1.** Select a Blackmagic Easy Setup. Final Cut Pro will sometimes warn that device control has been set to "non-controllable device". This is as expected. Click OK and then create a project with these settings.
- Step 2.** Choose File > Log & Capture. (Command + 8).
- Step 3.** Press play on HyperDeck Studio Pro and then press the Now button in the Log and Capture window. Final Cut Pro will show you a preview of the video you are capturing.
- Step 4.** Press esc to stop capturing.

If you can't see an image in your video capture window:

- Step 1.** Quit Final Cut Pro.
- Step 2.** Launch Blackmagic UltraScope. Note the output video standard that is displayed on the left side of UltraScope's Picture Display. Quit UltraScope.
- Step 3.** Launch Final Cut Pro and set the project preferences to match the standard reported by UltraScope.

48 Using Third Party Editing Software



Premiere Pro CC (2015)

Adobe Premiere Pro CC

When you install the HyperDeck Software, Blackmagic plug-ins are automatically installed to Adobe Premiere Pro CC.

Setting up a Blackmagic Design project

- Step 1.** Launch Premiere Pro.
- Step 2.** Create a New Project and click on the Scratch Disks tab.
- Step 3.** Set the desired Location and Name for your project at the bottom of this window.
- Step 4.** Set the locations for your captured video, captured audio, video previews and audio previews.
- Step 5.** If your graphics card is supported by Premiere Pro CC's Mercury Playback Engine, the Renderer option will be available and you should switch it to Mercury Playback Engine GPU Acceleration.
- Step 6.** Set the Capture Format to Blackmagic Capture and click on the Settings button to reveal the Blackmagic Capture Settings for your project. Set your desired Video Standard and Video Format.
- Step 7.** Select File > New Sequence to open the New Sequence window. To preserve maximum video quality, you can create a full resolution uncompressed sequence. To do so, click the discovery triangle next to "Blackmagic Design", select a preset to match the video standard and choose from uncompressed 8 bit YUV, 10 bit YUV or 10 bit RGB. If you don't have the storage space or disk speed for uncompressed video, choose a sequence preset that your computer system will be able to handle.
- Step 8.** When you have selected the desired sequence preset, give the sequence a name and click OK.

49 Using Third Party Editing Software

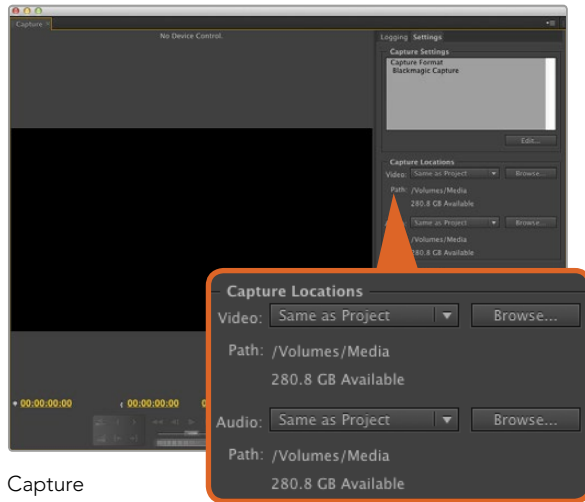

Capture



Photoshop CC (2015)

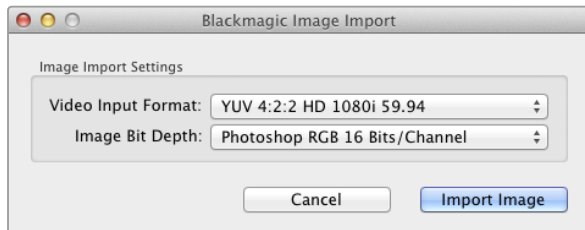

Image Capture

Capturing live via Thunderbolt

To capture video live via Thunderbolt from HyperDeck Studio Pro:

- Step 1.** Choose: File > Capture.
- Step 2.** Press 'play' on HyperDeck Studio Pro and then click the 'red record' button. A preview of the video you are capturing will appear.

To change the capture format, click on the 'settings' tab and then the 'edit' button. Ensure the 'capture format' is set to 'Blackmagic capture', click on the 'settings' button and then change the Blackmagic capture settings as desired.

If you can't see an image in your video capture window:

- Step 1.** Quit Premiere Pro.
- Step 2.** Launch Blackmagic UltraScope. Note the output video standard that is displayed on the left side of Ultrascope's picture display. Quit UltraScope.
- Step 3.** Launch Premiere Pro and set the project preferences to match the output video standard reported by UltraScope.

Adobe Photoshop CC

How to grab video frames

- Step 1.** From Photoshop select File > Import > Blackmagic Image Import
- Step 2.** Select the 'video input format' and the 'image bit depth' and then click 'import image'.

Once you have set the options in the 'import' window, each subsequent import will not display the window, so you can grab frames much faster. However if you would like to change your import format, hold the 'option' key when selecting import.

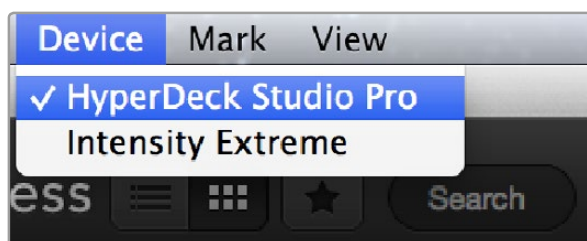

Select your HyperDeck Studio Pro from the Device menu.

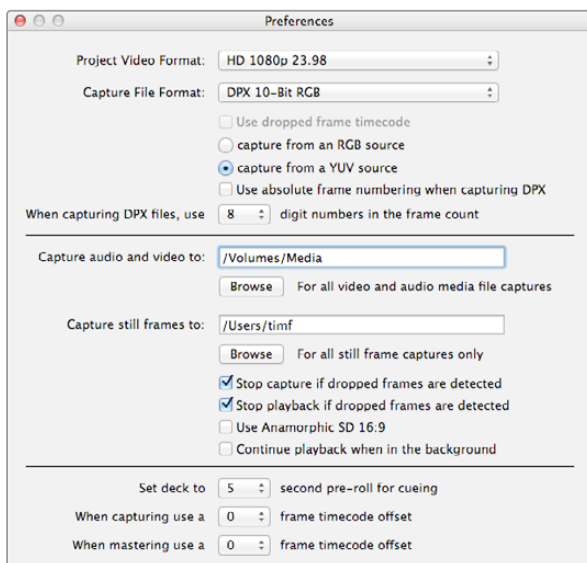

Use the preferences window to set project video format, capture file format, storage location and other settings.

What is Blackmagic Media Express?

Blackmagic Media Express software can be used to record directly from the HyperDeck Studio Pro model because it features built in Thunderbolt. Normally you would record into the SSD directly, however in some situations you can record into one file format on the SSD and a different format on a computer connected via Thunderbolt all at the same time. Blackmagic Media Express is a great tool when you don't need the complexity of NLE software, but simply want to capture video from HyperDeck Studio Pro's Thunderbolt port.

Selecting HyperDeck Studio Pro

If you have more than one Blackmagic Design capture product installed or connected to your computer, go to the 'device' menu in Media Express and select HyperDeck Studio Pro. In the example pictured on this page, Intensity Extreme and a HyperDeck Studio Pro are both connected to the same computer. Selecting HyperDeck Studio Pro will allow you to choose suitable video settings for your project.

Capturing Video and Audio Files

Setting Up a Project

Media Express automatically detects your input video format and sets the 'project video format' to match. If you want to set the project video format manually:

- Step 1.** Go to Media Express>preferences on Mac, or edit>preferences on Windows or Linux. Select your 'project video format' from the dropdown menu at the top of the preferences window. You can choose from a range of compressed and uncompressed capture formats, or even a DPX image sequence from the 'capture file format' drop down menu. Video will be captured in the chosen format and saved as a QuickTime movie. You can also choose to capture an RGB source using a YUV codec or vice versa.
- Step 2.** Set the storage location for your captured video and audio. Click the 'browse' button to point the software to a folder on your computer.
- Step 3.** Choose whether to stop capture or playback if dropped frames are detected.

Standard definition projects use the 4:3 aspect ratio unless you enable the 'use anamorphic SD 16:9' checkbox.

Applications will normally stop playing video if you send them to the background. Tick the checkbox 'continue playback when in the background' if you want Media Express to keep playing video even if you open another application.

The final options relate to tape decks with RS-422 deck control and include pre-roll and timecode offsets. These settings give you more flexibility when dubbing to third party tape decks using exact timecode entries. Using the RS-422 port, an RS-422 controller can be connected to a third party tape deck so you can control the deck, which also gives you the option to control your HyperDeck externally.

51 Using Blackmagic Media Express

Capturing Video and Audio Files

The screenshot shows the Blackmagic Media Express interface with several components labeled:

- Media List:** Points to the left sidebar containing clip bins like "Scratch", "Today's rushes", "VFX plates", and "New shots from location 2".
- Timecode List, Thumbnail and Favorites view:** Points to the top of the Media List area.
- Search Field:** Points to the search bar at the top right of the Media List.
- VTR / deck timecode:** Points to the timecode display at the top of the video preview window, showing "00:00:07:07".
- Video Preview:** Points to the main video preview window showing a fighter jet.
- Project name, video format and frame rate:** Points to the project name "Project Untitled HD 1920x1080p 23.98fps" at the bottom left.
- Clip Bins:** Points to the "Scratch" bin header.
- Mark In / Mark Out:** Points to the "In:" and "Out:" timecode fields in the transport controls.
- Grab Still Frame:** Points to the still frame grab button (camera icon) in the transport controls.
- Logging Information:** Points to the "Log" button in the transport controls.
- Capture options:** Points to the "Capture", "Clip", and "Batch" buttons in the transport controls.
- Transport Controls:** Points to the playback controls (stop, play, fast forward, etc.) in the transport controls.
- Audio channel enable/disable:** Points to the "V 1 2 3 4 5 6 7 8 9 10 11 12 13 14 15 16" indicator in the transport controls.
- Audio Meters:** Points to the audio level meters on the right side of the transport controls.
- Remote indicator:** Points to the "VTR OK" indicator in the top right of the transport controls.

52 Using Blackmagic Media Express

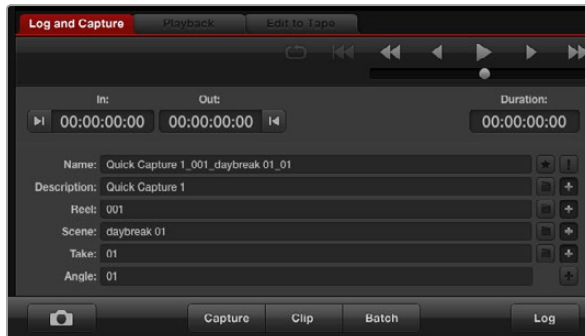

Enter a description for your video



Set the desired number of audio channels to be captured

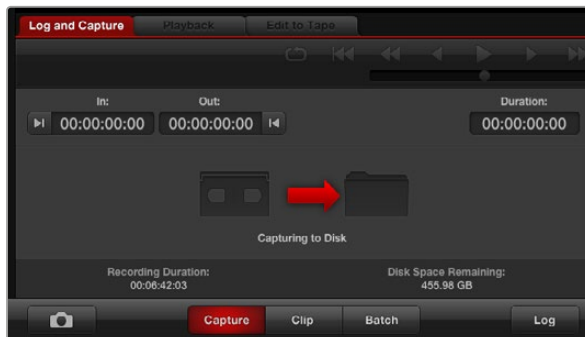

Click the Capture button to commence recording

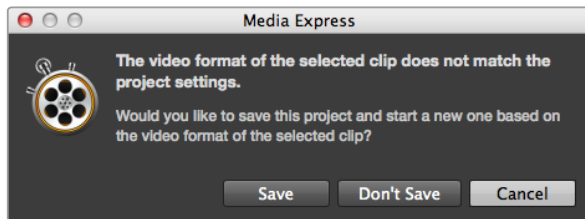

Media Express alerts you if the video input format changes.

Capture

Capturing video is easy. All you need to do is connect HyperDeck Studio Pro via a Thunderbolt cable, set the Media Express preferences and press the 'capture' button.

- Step 1.** Connect your video source to an input on HyperDeck Studio Pro. Check that HyperDeck Studio Pro is set to the input you have connected your source to. e.g. SDI, HDMI or analog.
- Step 2.** Open Media Express and click the red 'log and capture' tab.
- Step 3.** Your source video will appear in the preview pane. Enter a description into the 'description' field.
- Step 4.** Click the '+' button next to the description to add it to the automatic 'name' field. Click the '+' button next to any of the other fields that you wish to add to the name field.
 - To increment the value in each of these fields, click the corresponding clapper board icon. Alternatively, type directly into any field to customize its name and number.
 - The text in the automatic name field will be applied to the clip(s) about to be captured.
 - To log the clip as a favorite, click the star icon next to the name field.
 - For a clip name confirmation prompt to appear before every capture, click the '!' icon next to the name field.
- Step 5.** Set the desired number of audio channels to be captured.
- Step 6.** Click the 'capture' button to start recording. To stop the capture and keep the clip, click the 'capture' button again or press esc. The captured clips are added to the media list on the left side of Media Express.

If the video input format changes from the project video format, Media Express will automatically detect it and will prompt you to save the current project and create a new one.

53 Using Blackmagic Media Express

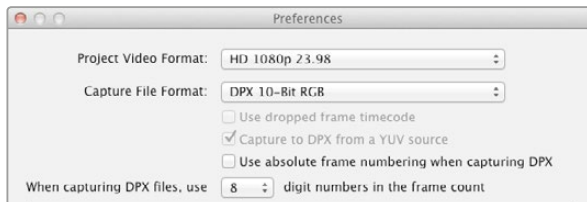

DPX capture preferences

DPX Capture

If you want to capture a DPX image sequence rather than a movie file, open the 'Media Express preferences' and follow the steps below:

- Step 1.** Make sure you connect your video source to an input on HyperDeck Studio Pro and check that HyperDeck Studio Pro is set to the input you have connected your source to. e.g. SDI, HDMI or analog.
- Step 2.** Select the 'capture file format' to DPX 10-Bit RGB. You will need a fast disk array to cope with the uncompressed 10-Bit RGB format.
- Step 3.** Click the 'capture' button to start recording. To end capture, click the 'capture' button again to automatically save the clip to the media list.

When the capture has been completed, a single thumbnail will appear in the media list representing the entire frame sequence. The sequence of DPX frames will be stored in its own folder in your disk storage. Audio will be stored in a .wav file in the same folder.

By default, DPX captures are assumed to be from YUV sources. If you are capturing from an RGB source, select 'capture from an RGB source'.

If you want the DPX frame numbers to be based on the timecode of the captured video, rather than just starting from zero, enable the option to 'use absolute frame numbering when capturing DPX'.

If you aren't performing long DPX captures, you may wish to reduce the number of zeroes in the frame numbers by changing the option, 'when capturing DPX files, use (2-8) digit numbers in the frame count'.

54 Using Blackmagic Media Express

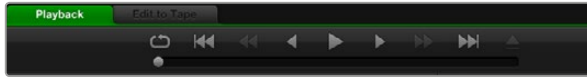

You can use the transport controls to play, stop, jump to the next or previous clip and loop playback.



If the imported clips do not match the existing clips, you will be prompted to create a new project.

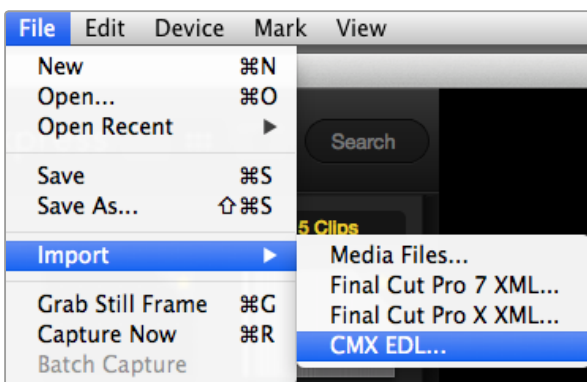

You can import media directly, or import with an XML or EDL.

Playing back Video and Audio Files

Playing back single and multiple clips

To play back a single clip, double-click the clip in the media list. Alternatively, select the clip in the media list and press the space bar on your keyboard or the play button in the transport controls.

To play back multiple clips, select the clips in the media list and then press the space bar on your keyboard or the play button in the transport controls.

Your video will play back in the video preview pane of Media Express and on all the video outputs of your Blackmagic Design video hardware. During playback, the audio channels being monitored can be switched on or off via the track enable/disable buttons.

Importing clips

You can play back your video and audio files after importing media into Media Express in any of the following ways:

- Double-click an empty area of the media list.
- Right-click an empty area of the media list and select 'import clip' from the contextual menu.
- Go to the 'file' menu, select import and then 'media files'.

Select the video and audio clip(s) you wish to import from the 'open video clip' dialog box. The clips will appear in the 'scratch' area of the media list. If you have created your own bins in the media list, you can drag the clips into the desired bin.

To import directly to a bin, right-click within the desired bin and select 'import clip' from the contextual menu.

If the files being imported do not match the frame rate and size of existing clips in the media list, you will be prompted to create a new project and to save the current project.

Media Express also supports the import of multichannel audio-only files recorded at 48kHz in the uncompressed WAVE and AIFF formats.

Another way to import media is to use an XML file exported from an NLE such as Final Cut Pro 7 or Final Cut Pro X. Go to the 'file' menu, select 'import' and then either Final Cut Pro 7 XML or Final Cut Pro X XML. Open the desired XML and all the bins and media from the Final Cut Pro project will appear in the media list.

Media Express also supports the import of CMX EDL files to batch capture clips using EDL files from other video software. Go to the 'file' menu, select 'import' and then CMX EDL. Select the EDL and open it. The logging information will appear in the media list. Select the logged clips and perform a batch capture to import the clips from your deck.

55 Using Blackmagic Media Express

Playing back Video and Audio Files

The screenshot displays the Blackmagic Media Express software interface. On the left, a 'Media List' shows various video clips organized into bins: 'Scratch' (6 clips), 'Todays rushes' (12 clips), 'VFX plates' (14 clips), and 'New shots from location 2' (5 clips). Each clip thumbnail includes a title and duration. The main area on the right is the 'Video Preview' window, showing a video of a fighter jet in flight. A 'VTR / deck timecode' display at the top of the preview window shows '00:00:07:07'. Below the preview is a control panel with 'Log and Capture', 'Playback', and 'Edit to Tape' buttons. The 'Playback' section includes transport controls (stop, play, fast forward, fast reverse) and a 'VTR OK' indicator. The 'Clip Information' section shows 'In:' and 'Out:' timecodes (both at 00:00:00:00) and a 'Duration:' of 00:00:00:00. Below this are fields for Name, Description, Reel, Scene, Take, and Angle. The bottom of the interface features a 'Project name, video format and frame rate' display (Project Untitled HD 1920x1080p 23.98fps), 'Clip Bins' (camera and star icons), 'Mark In / Mark Out' buttons, 'Grab Still Frame' and 'Favorites Selection' buttons, 'Transport Controls' (a row of 16 buttons labeled 1-16), 'Audio channel enable/disable' buttons, 'Audio Meters' (a row of 16 vertical meters), and a 'Remote indicator'.

Media List

Timecode List, Thumbnail and Favorites view

Search Field

VTR / deck timecode

Video Preview

Media Express

Search

▼ "Scratch" 6 Clips

1080p 23 ProRes 2cl Dur: 00:00:20:01

ZOIC 2008 Craftsmen Dur: 00:00:30:01

ZOIC 2008 Sea Work Dur: 00:00:30:01

ZOIC 2008 Sprite 10f Dur: 00:00:30:01

ZOIC 2008 TV 1080p Dur: 00:01:53:22

ZOIC 2010 1080p 23 Dur: 00:05:12:14

▼ Todays rushes 12 Clips

ZOIC 2010 1080p 23 Dur: 00:03:12:17

ZOIC 2010 1080p 23 Dur: 00:02:46:09

ZOIC 2010 1080p 23 Dur: 00:00:30:00

ZOIC 2010 1080p 23 Dur: 00:00:21:02

ZOIC 2010 1080p 23 Dur: 00:02:46:09

ZOIC 2010 1080p 23 Dur: 00:00:30:00

ZOIC 2010 1080p 23 Dur: 00:01:15:16

ZOIC 2011 1080p23 Dur: 00:02:58:16

ZOIC 2010 1080p 23 Dur: 00:01:15:16

1080p 23 ProRes 2cl Dur: 00:00:20:01

ZOIC 2011 1080p23 Dur: 00:02:56:16

ZOIC 2008 Sprite 10f Dur: 00:00:30:01

▼ VFX plates 14 Clips

ZOIC 2010 1080p 23 Dur: 00:01:15:16

ZOIC 2010 1080p 23 Dur: 00:00:30:00

ZOIC 2010 1080p 23 Dur: 00:03:12:17

ZOIC 2010 1080p 23 Dur: 00:00:21:02

ZOIC 2010 1080p 23 Dur: 00:00:30:00

ZOIC 2008 Craftsmen Dur: 00:00:30:01

ZOIC 2008 Sea Work Dur: 00:00:30:01

ZOIC 2008 TV 1080p Dur: 00:01:53:22

ZOIC 2010 1080p 23 Dur: 00:05:12:14

ZOIC 2010 1080p 23 Dur: 00:03:12:17

ZOIC 2010 1080p 23 Dur: 00:02:46:09

ZOIC 2010 1080p 23 Dur: 00:00:30:00

ZOIC 2010 1080p 23 Dur: 00:00:30:00

ZOIC 2010 1080p 23 Dur: 00:00:21:02

▼ New shots from location 2 5 Clips

Project Untitled HD 1920x1080p 23.98fps

00:00:07:07

Log and Capture Playback Edit to Tape VTR OK

In: 00:00:00:00 Out: 00:00:00:00 Duration: 00:00:00:00

Name: Description: Reel: Scene: Take: Angle:

Project name, video format and frame rate

Clip Bins

Mark In / Mark Out

Clip Information

Grab Still Frame

Favorites Selection

Transport Controls

Audio channel enable/disable

Audio Meters

Remote indicator

56 Using Blackmagic Media Express

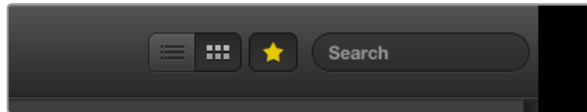

In the media list, choose to view your clips in 'timecode list' view or 'thumbnail' view. Click the 'favorites' button to show only your favorite clips. Type in the search field to find your favorite clips.

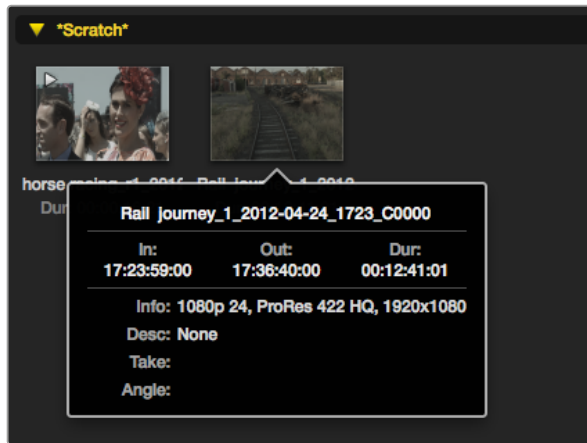

Click a thumbnail's popup info icon to view the info bubble.

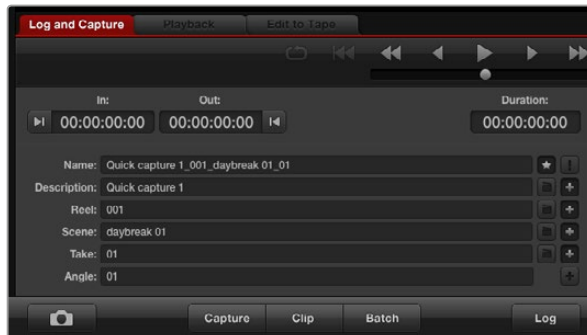

In the 'log and capture' tab, click the 'star' icon next to the name field if you want to log the clip as a favorite.

Browsing Media

Thumbnail view

Thumbnails are the most intuitive way to display your clips. Hover your mouse over the clip's thumbnail and then click on the popup info icon at the bottom-right of the thumbnail. Click the info bubble to hide it.

List view

You can view your clips in 'timecode list' view by clicking on the 'timecode list' button at the top-right of the media list. Use the horizontal scroll bar to view all the columns of information for your clips.

Creating and using bins

To create a bin, right click an empty spot in the media list and select 'create bin'. Name the new bin.

You can move clips around by dragging the clip icons to the desired bin. If you want a clip to appear in more than one bin, import the same clip again by right-clicking on the bin and choosing 'import clip'.

By default, logged clips appear in the 'scratch'. If you want to log clips and have them appear in a new bin, right-click the new bin and choose 'select as log bin'.

Creating and using favorites

In the 'log and capture' tab, click the 'star' icon next to the name field if you want to log a clip as a favorite.

In the 'playback' tab, clicking the star icon will make the clip a favorite if it is selected in the media list. Click the star icon again to deselect it as a favorite.

Clips marked as favorites will show a yellow star in their icon in 'timecode list' view and 'thumbnail' view.

Once you have marked clips as favorites, click on the 'show only favorites' button at the top of the media list. The star icon will turn yellow. All clips will be hidden except for those marked as favorites.

Linking an audio clip to a video clip

To link an audio clip to a video clip in the media list:

- Select a video clip which contains no audio channels.
- Right-click on the video clip and select 'link audio file' from the contextual menu.

You can now play back the combined clip or master it to tape.

57 Using Blackmagic Media Express

Deleting clips and bins

To delete clips, select the unwanted clips and press the forward delete button on your keyboard. This will only delete the clips from the media list and they will safely remain on your disk storage.

To delete bins, right-click within a bin and choose 'delete bin'. This action will delete the bin and any clips it contained. This will only delete the clips from the media list and they will safely remain on your disk storage.

Searching the Media List

Clips can easily be found in a project by typing the name of your clips in the 'search' field at the top of the media list. When used in conjunction with the favorites feature, the search will be confined to your favorite clips so you will see a shorter list of found clips.

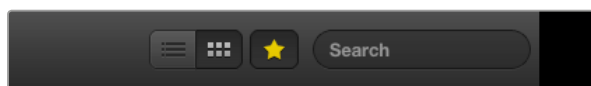

Click the Favorites button at the top of the Media List to only show your favorite clips. Type in the Search field to find clips.

58 Using Blackmagic UltraScope

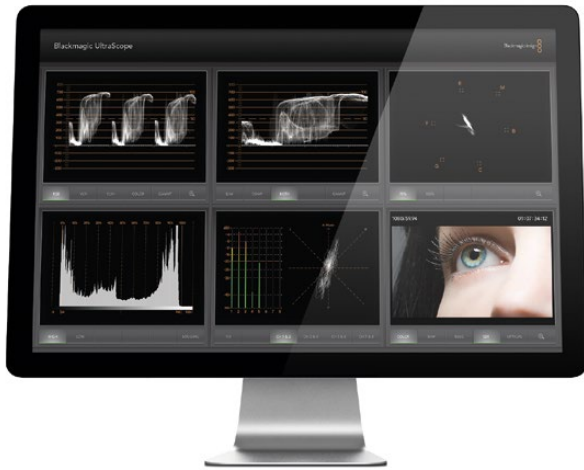

Blackmagic UltraScope

What is Blackmagic UltraScope?

With HyperDeck Studio Pro you get the incredible features of Blackmagic UltraScope, which you can even use with compatible Mac OS X and Windows notebook computers with Thunderbolt technology! Blackmagic UltraScope software is installed by the HyperDeck Studio Pro Installer.

Previously broadcast quality television and post production scopes were incredibly expensive custom solutions that only let you see one scope at a time on a tiny screen! Some scopes look ugly and don't really look good in front of your client. With Blackmagic UltraScope, you get 6 wonderful scopes that let you see all aspects of your video signals!

Blackmagic UltraScope is perfect for quality control checks of the output of your HyperDeck Studio Pro, no matter which video input you use. Simply connect a Thunderbolt cable from your HyperDeck Studio Pro to a Thunderbolt enabled computer and away you go!

Installation Requirements

HyperDeck Studio Pro connects to both Mac OS X and Windows computers with Thunderbolt technology.

The Blackmagic UltraScope software interface requires a computer display with a minimum resolution of 1280 x 800 pixels to view two scopes simultaneously. Blackmagic Design recommends viewing all 6 scopes simultaneously by using a computer display resolution of 1920 x 1200 or 1920 x 1080 pixels.

Please see the support pages at www.blackmagicdesign.com for a comprehensive list of the latest minimum system requirements for Blackmagic UltraScope for Mac OS X and Windows.

59 Using Blackmagic UltraScope

Blackmagic UltraScope Interface

1. Parade Display

2. Waveform Display

3. Vectorscope Display

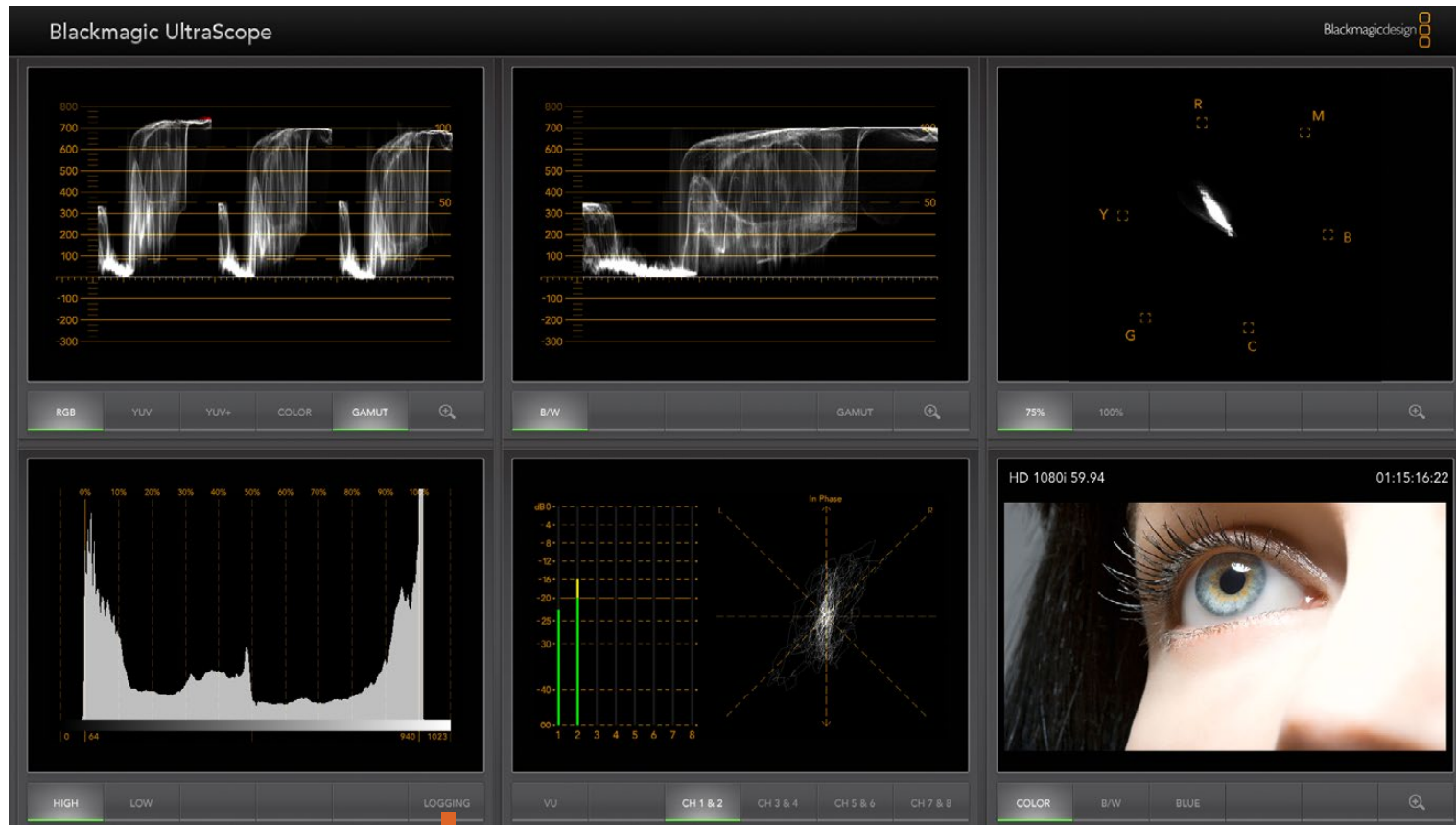

4. Histogram Display

5. Error Logging

6. Audio Metering Display

7. Picture Display

60 Using Blackmagic UltraScope



Full Screen view



2-Up view

Understanding Blackmagic UltraScope Views

Blackmagic UltraScope has two different views available depending on your workflow needs and screen resolution. You have the choice of viewing six displays in 'full screen' view, or for more compact viewing, choose any 2 displays in '2-up' view.

The display view can be selected from the 'view' menu.

Choose 'full screen' to enter 'full screen' view. If this option is unchecked, '2-up' view will be displayed. You can quickly switch between full screen view and 2-up view by using the hot key 'command+f' on Mac OS X.

In '2-up' view, select the desired left and right scopes by opening the 'view' menu or by right-clicking anywhere in the UltraScope window. Make your selections from the 'left view' and 'right view' menu options. If you attempt to choose the same scopes for both the 'left view' and 'right view', the existing scopes will swap sides.

Screen Resolution Requirements for Display Views

- Full Screen view: 1920 x 1200 pixels or 1920 x 1080 pixels. If your monitor doesn't support these resolutions, then full screen view will not be available.
- 2-up view: minimum resolution of 1280 x 800 pixels.

61 Using Blackmagic UltraScope



Zoom Function

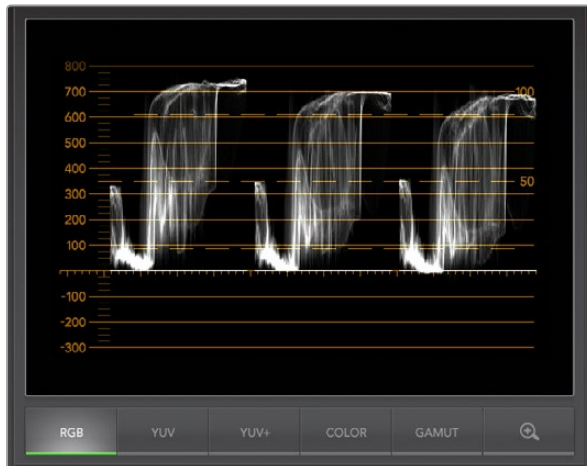
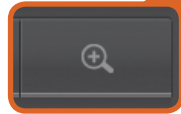



Parade Display

Zoom Function

Blackmagic UltraScope allows you to zoom in on various displays for a more detailed analysis. This helpful function will also pan and zoom the graticules for each display in high resolution.

The zoom function is available in the Parade, Waveform, Vectorscope and Picture displays.

To zoom in, simply click  on the bottom right of each respective display. Now you will be able to view the display in finer detail. Drag the mouse within the display area to pan around the zoomed display.  Clicking again, will return the display back to its normal view.

Parade Display

Parade Display is perfect for checking for illegal colors and checking levels.

Press the RGB button to display the full height of each color channel as red, green and blue. Monitoring the levels of each red, green and blue color channel makes it is easy to view color balance in the blacks, mids and whites of the video signal. Parade Display enables you to identify details common to the red, green and blue channels.

It's often important to make sure you're not clipping the video levels. Make sure the video is full level but not clipped. You can turn on the GAMUT function, and any illegal levels will be highlighted in bright red, so they are easy to see. Instructions for setting gamut limits can be found in the Error Logging Display section of this manual. If you want to increase the video level, then make sure it doesn't go above upper RGB limit or you will encounter illegal levels. Some equipment won't let you generate illegal 100% RGB levels, however other equipment will. Blackmagic UltraScope lets you see illegal levels whenever they occur.

Illegal video can also happen in blacks as well as whites. Some equipment produces black levels which can be lowered below the black point of 0%. The levels will be shown as bright red if this falls below the lower gamut limit and the GAMUT warning mode is enabled. If you observe illegal black levels, just add some "lift" or gain to eliminate them but check the 100% graticule level to make sure the whole video signal has not lifted and generated illegal colors in the whites.

To check levels, simply press the YUV or YUV+ button.

The COLOR setting switches the RGB display to color rather than traditional black and white. When the COLOR setting is used with the YUV or YUV+ display, luma (brightness) remains white, B-Y (difference between blue and luma) appears blue and R-Y (difference between red and luma) appears red. The COLOR setting is not a professional setting and should usually be switched off, especially when showing video to clients.

62 Using Blackmagic UltraScope

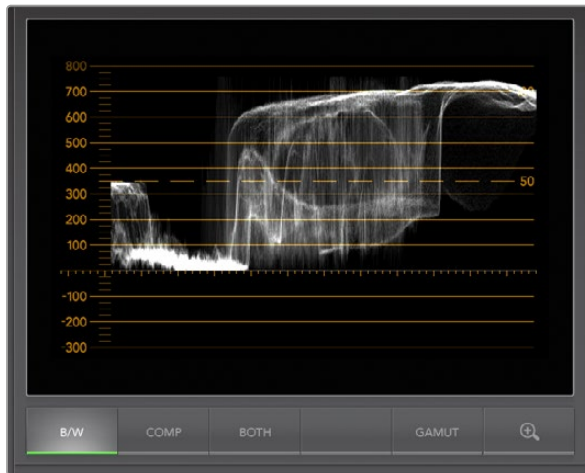

Waveform Display on Windows can show Luminance, Composite or Both views.

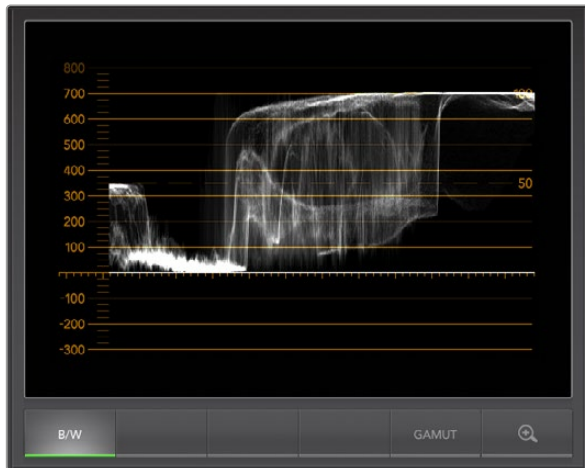

Waveform Display on Mac OS X always shows Luminance view.

Waveform Display

The Waveform Display is similar to traditional composite waveform monitors seen in many broadcast studios. On Mac OS X, the Waveform Display always shows the luminance view and the B/W button is permanently selected. On Windows, select B/W for the luminance only view, COMP for the composite only view, and BOTH for the twin luminance and composite view.

Select B/W for the luminance view which provides a digitally encoded waveform similar to traditional luminance waveform monitors. The luminance view is very useful when adjusting luma (brightness) levels in an image. Turn on the GAMUT function, and any illegal luma levels will be highlighted in bright red, so they are easy to see. Instructions for setting luma limits can be found in the Error Logging Display section of this manual. Traditional luminance waveform monitors only supported composite analog standard definition video. However UltraScope's luminance view works in high definition as well as standard definition, so you have a consistent and easy way to adjust luma levels even when monitoring high definition digital video formats!

For Windows users, the composite view is exciting because it's a fully digitally encoded composite waveform view and similar to a traditional waveform monitor. This provides a much easier way to align to test signals, such as color bars, because you can use the composite waveform exactly the same way as it has always been used. Composite view also works in high definition, so you have a consistent and traditional way to adjust video even when working in high definition!

When BOTH view is selected on a Windows PC, the composite and luminance waveforms display side by side in a twin view. This is incredibly useful when adjusting video levels or color correcting. It's impossible for a vectorscope to show which objects in the video have color because a vectorscope just shows what colors are in the whole image and not which objects have color. When color correcting, you often need to look for specific parts of the image, remove the color and produce a neutral state. This is because the composite waveform is the same as the luminance signal but with chroma added.

Choosing this twin view makes it easy to identify similar items in the luminance and composite waveforms, and if more blur or chroma is observed in the composite area, the item has color. If some part of the video image is neutral gray, then it should look the same on both waveforms because no chroma will be present. With the twin view, you can look around the waveform and see the levels of color or chroma of various objects. As you color correct, the composite waveform will display more or less chroma in the video signal. Now you can see if specific objects in the video image are color or black and white. You can make technical and creative decisions using the Waveform Display.

When the Waveform display is zoomed in, you can toggle between COMP and B/W, and view the same region of an image in the zoomed display.

63 Using Blackmagic UltraScope



Vectorscope Display

Vectorscope Display

The Vectorscope Display uses a vector view to show the colors in a video signal. You can see color bar video levels by using the color boxes in the graticule. All you need to do is select 75% or 100% color bars, depending on the standard of color bar test signals used in your facility!

Some people think you can use a vectorscope to check for illegal levels. However this is not correct and the Parade Display should be used, and set to RGB, for checking for illegal colors. The reason you cannot use a vectorscope to check for illegal levels is that both chroma and luminance values are required. For example, colors near the white or black points in video cannot be as saturated as the much stronger colors, which can be used in the mid-grays. Because Vectorscope Display only shows colors, and not luminance values, it cannot be used to check for illegal colors.

Vectorscope Display is the best tool for checking color levels from older, analog videotape where you need to adjust chroma levels. Just play back the color-bar segment of the videotape, and then adjust the chroma and hue settings, to set the colors of the video within the square boxes in the graticule.

Vectorscope Display is also perfect for color grading, as you can easily see if your video is correctly white-balanced or if there is a color tint. If your video has a color tint, the Vectorscope display will drift off-center, and you might see two center dots. Normally the blanking in the video signal will create a dot in the center of the vector scope, and this is because the blanking in the video is black video without any color. Blanking provides a useful reference point to help recognize areas of black video without any color information.

If your video has a color tint, you should see the blacks move off-color and off-center. The degree of shift represents the amount of color tint in your video and you can see the shift in both the white and black details of your video. This makes Vectorscope Display valuable for removing color tint and regaining correct white balance.

Vectorscope Display lets you push colors in your video to the limits, without accidentally adding unwanted color tints to blacks and whites. While color balance can be monitored on both the RGB Parade Display and Vectorscope Display, color balance issues will often be easier to see in Vectorscope Display.

When color correcting footage of skin tone, particularly faces, you will want to keep your warm color saturation along a line at approximately 10 o'clock on the vectorscope. This is known as the "fleshtone line" and is based on the color of blood beneath the skin's surface. The fleshtone line is therefore applicable to all skin pigmentations and is the best way to ensure the skin tones of your talent look natural.

64 Using Blackmagic UltraScope

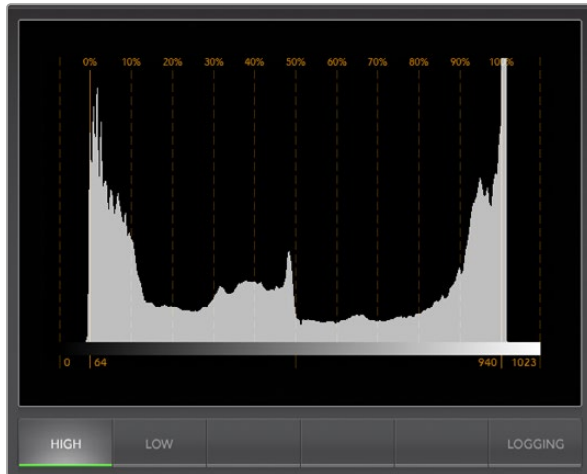

Histogram Display

Histogram Display

Histogram Display is most familiar to graphic designers and camera operators. Histogram Display shows the distribution of white to black information and lets you monitor how close the detail is to being clipped off in the whites or blacks of the video. Histogram Display also lets you see the effects of gamma changes in the video.

Black video is shown on the left of the display, and whites are shown on the right. All video should usually be found between the 0% and 100% intervals of the Histogram Display. Your video is being clipped if it moves below 0% or above 100%. Video clipping can be really bad, when you're on a shoot, as detail in the blacks and whites must be preserved if you subsequently want to perform color-correction in a controlled environment. When shooting, keep the video above the black clip, and below the white clip, so you can have more freedom later to adjust colors without whites and blacks appearing flat and lacking in detail.

When color-correcting, you might decide to clip your video, and in which case Histogram Display will show the effect of clipping the video, and how much it is being clipped. You can even use gamma to create a similar look, with less clipping, while retaining more detail.

You cannot really use Histogram Display to check for illegal levels although you can use it to see illegal blacks and whites. Histogram Display does not show colors and so the histogram might appear to show legal levels, even though your video may contain illegal colors. Again, RGB Parade Display provides the best way to watch out for illegal levels as it shows them in both the color and luminance elements of the video signal.

The HIGH and LOW buttons simply control how bright the histogram appears on your computer display. If you find the white area of the histogram is too bright in a dark studio, choose LOW for a more comfortable brightness level.

65 Using Blackmagic UltraScope



From the Histogram Display, select the Logging button to switch to the Error Logging Display.

The screenshot shows the Error Logging Display in the UltraScope application. It displays a table of error logs with the following columns: START TC, END TC, DUR, DESCRIPTION, VALUE, and START TIME. Below the table are buttons for START, CLEAR, SAVE, and HISTOGRAM.

START TC	END TC	DUR	DESCRIPTION	VALUE	START TIME
01:28:53:18	01:28:54:05	0.53	Audio Level 1	-1 dBFS	14:03:52:68
01:28:53:26	01:28:54:05	0.28	Audio Level 2	-1 dBFS	14:03:52:93
01:28:54:07	01:28:54:27	0.65	Audio Level 2	0 dBFS	14:03:53:29
01:28:54:07	01:28:54:27	0.65	Audio Level 1	0 dBFS	14:03:53:29
01:28:54:29	01:28:55:22	0.77	Audio Level 1	0 dBFS	14:03:54:03
01:28:54:29	01:28:55:22	0.77	Audio Level 2	0 dBFS	14:03:54:03
01:28:55:24	01:28:56:03	0.28	Audio Level 1	-1 dBFS	14:03:54:88
01:28:55:24	01:28:56:22	0.90	Audio Level 2	0 dBFS	14:03:54:88
01:28:56:05	01:28:56:15	0.33	Audio Level 1	0 dBFS	14:03:55:25
01:28:56:16	01:28:56:28	0.41	Audio Level 1	2 dBFS	14:03:55:62
01:28:56:23	01:28:57:05	0.41	Audio Level 2	2 dBFS	14:03:55:82
01:28:57:01	01:28:58:17	1.55	Audio Level 1	0 dBFS	14:03:56:06
01:28:57:07	01:28:58:16	1.26	Audio Level 2	0 dBFS	14:03:56:31
01:28:58:10	01:28:59:01	0.45	Audio Level 1	-0 dBFS	14:03:57:66
01:28:58:10	01:28:59:01	0.45	Audio Level 2	-1 dBFS	14:03:57:66
01:28:59:03	01:29:00:14	1.26	Audio Level 1	0 dBFS	14:03:58:18
01:28:59:03	01:29:00:14	1.26	Audio Level 2	0 dBFS	14:03:58:18
01:29:00:15	01:29:01:20	1.19	Audio Level 1	0 dBFS	14:03:59:49
01:29:00:15	01:29:01:20	1.19	Audio Level 2	0 dBFS	14:03:59:49
01:24:54:18	01:29:01:21	247.04	Red Over	114 IRE	13:59:53:68
01:24:54:18	01:29:01:21	247.04	Luma Under	-2 IRE	13:59:53:68
01:24:54:18	01:29:01:21	247.04	Luma Over	109 IRE	13:59:53:68

Error Logging Display

Error Logging records errors in video and audio and is indispensable when reviewing video and for unattended operation. Errors may be logged for color, brightness or audio threshold levels as well as loss of video signal, change of video format or audio silence. After setting the parameters which define when an error should be logged, you can choose to start or stop error logging, save the log to a file, or clear the log. These functions can be selected from the buttons in the Error Logging Display or from the Error Logging pulldown menu.

Errors are recorded against timecode and time of day to make them easy to find. If the timecode is not present, errors can be found by reviewing the time of day at which they were recorded. As computer clocks can drift, it is a good idea to inspect the Date & Time settings on your computer, and set the clock to synchronize with an Internet time server to ensure accurate time of day logging.

In the Full Screen view, Histogram Display and Error Logging Display share the same area of the UltraScope interface. Select the LOGGING button, below the Histogram Display, to switch to the Error Logging Display. Select the HISTOGRAM button, below the Error Logging Display, to switch back to the Histogram Display. After quitting and reopening the UltraScope application, the last viewed display will be made visible again, i.e. either Histogram or Error Logging.

In 2-up view, Histogram Display and Error Logging Display can be viewed simultaneously and so there are no LOGGING or HISTOGRAM buttons.

When viewing the Error Logging Display for the first time, the display will initially be blank other than for some column headings. Select the START button to commence logging. In Full Screen view, you can switch back to the Histogram Display and UltraScope will continue to perform error logging until you choose to stop it.

When error logging is being performed, the STOP button replaces the START button. When the STOP button has been selected, you can choose to START again and any new errors will be appended to the existing log. When error logging has been stopped, you can choose to SAVE the log to a CSV file or alternatively CLEAR the log. The SAVE and CLEAR buttons will not appear if no errors have been recorded. The CSV file can be analyzed in many applications including spreadsheet and database software.

By default, error logging is performed using the EBU-R103 standard which is set down by the European Broadcasting Union. This standard is popular worldwide and is commonly used as a template for making new error logging profiles.

66 Using Blackmagic UltraScope

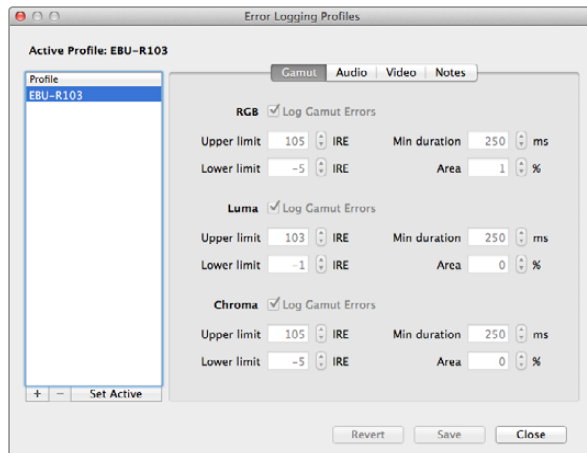

Gamut error tolerance settings for color and brightness

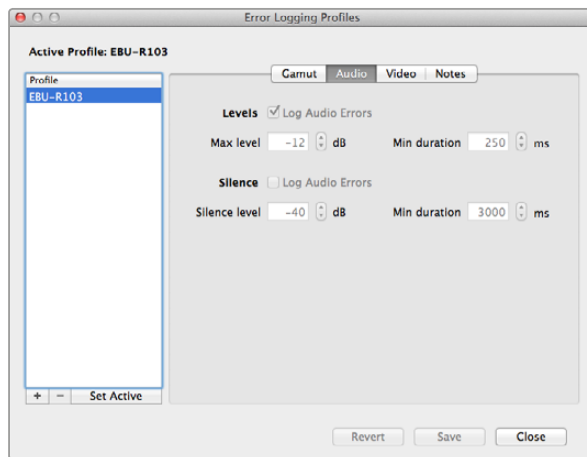

Audio error tolerance settings

How to Customize Error Logging

To customize error logging, go to the Error Logging menu and choose Profiles to open the Error Logging Profiles window. Saved profiles appear in the profile list at the left and the current active profile appears in bold above the list.

The standard EBU-R103 profile cannot be deleted or modified and is grayed out. You can add a profile by clicking the add (+) button and typing a name for your profile. The new profile will initially contain the same parameters as the EBU-R103 profile but these can be changed as required.

Under the Gamut tab, upper and lower limits can be adjusted as a percentage of IRE units for RGB, Luma and Chroma. Set the minimum time in milliseconds (ms) for which these conditions must be sustained before being logged as errors. Set the percentage area, of pixels in error to total pixels in a frame, below which errors can be ignored. The Area setting acts like sensitivity.

Under the Audio tab, the maximum audio level can be set in decibels (dBFS) as can the audio level below which audio is regarded as silence. Set the minimum time in milliseconds (ms) for which these conditions must be sustained before being logged as errors.

Under the Video tab, loss of video signal and change of video format can be logged as errors.

Under the Notes tab, write a brief description of the new profile to help distinguish it from other profiles.

To modify a new or existing profile, ensure it is selected and then change its parameters as desired. Press Save to save these changes or choose Revert to leave the profile unchanged.

Choosing Save saves the changes to the profile but does not determine which profile is active. To activate a profile, select it from the profile list and then choose Set Active.

You can delete a profile by selecting it in the profile list and clicking the delete (-) button.

67 Using Blackmagic UltraScope

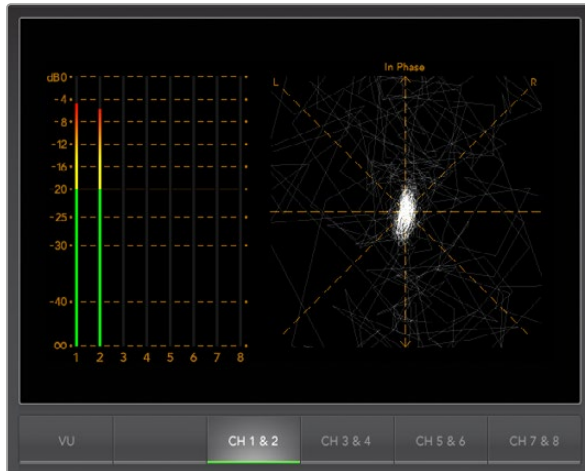

Audio Metering Display

Audio Metering Display

Audio Metering Display shows you the audio levels in the embedded audio of the HyperDeck Studio Pro's video signal. 8 channels of embedded audio from your HyperDeck Studio Pro are de-embedded and then displayed in either dBFS or VU format. The VU button switches between dBFS and VU audio metering standards.

dBFS is essentially a meter of the overall digital audio signal and is common on modern digital equipment.

The VU meter shows average signal levels, is easy to use and very common on older equipment. VU is calibrated to the SMPTE recommendation of a 1 kHz tone test signal set to -20 dBFS.

The right hand audio scope can monitor two channels of audio. The audio scope presents audio in an X-Y view so you can see audio balance issues, out of phase conditions and whether an audio track is mono or stereo. Mono audio should appear as a single, vertical, "in phase" line. If the line is horizontal, then your audio is "out of phase" and could cancel out (i.e. loss of audio) when received by downstream equipment. Audio phase is one of the most common audio faults in large facilities, where cables can be incorrectly connected.

When monitoring stereo signals, the line of the right hand audio scope fans out to represent the difference between the left and right audio channels. The more stereo sound contained in the audio track, the more circular the line will appear. If the audio contains minimal stereo content, then the scope will appear more concentrated around the vertical axis.

While spoken dialog tends to appear as a vertical line, music with plenty of stereo content will puff out. This is because mono audio is L+R, and will display on the vertical axis, whereas stereo content is L-R, and will display on the horizontal axis to show the stereo difference.

68 Using Blackmagic UltraScope



Picture Display

Picture Display

The Picture Display is a handy confidence monitor so you can see the video that is being received by Blackmagic UltraScope. The Picture Display has three settings: COLOR, B/W (black & white) and BLUE (Blue Only).

Set to COLOR or B/W depending on the needs of your facility. Black & white is popular for use in color-correction studios so clients don't get confused when seeing multiple color displays, and not understanding which color display is the correct, color-calibrated display. You may wish to select B/W so there is only a single calibrated color display in the room. The black & white display can also provide a useful visual reference.

Blue Only is used with color bar test signals for setting hue on playback decks. When adjusting hue, make sure all the blue bars are a constant brightness to attain the correct hue level.

Blue Only can also be used for evaluating noise levels in cameras and telecines. Blue has the least amount of signal level, in a color video signal, and so is more susceptible to noise. The BLUE setting can provide a good way to check on noise levels in a video signal.

The Picture Display will also decode RP-188 HD and VITC SD timecode information, from an SDI video input signal, and display it on the right side of the display. If the timecode information is incorrect, check your deck to ensure it is outputting the correct timecode signal encoded as VITC or RP188.

It is worth noting that some standard definition broadcast decks let you "re-stripe" the timecode track independently of the VITC, which was encoded as part of the image. This meant the VITC could not be changed without copying the video down another generation. Consequently some standard definition decks had different timecode in the VITC to the normal LTC track on the SDI video output. It is always worth checking master tapes if you think the displayed timecode is incorrect.

The Picture Display will also show timecode internally generated by your HyperDeck Studio Pro when Generate is selected in the Ancillary Data>Timecode>Mode Select menu.

Lastly, the video standard is displayed on the left side of the Picture Display, so you can verify the video standard being output by your HyperDeck Studio Pro. This information is great for independently checking that the correct video standard is being output without having to use external monitoring equipment. If the displayed video standard is not what you expected, you should check the output settings on HyperDeck Studio Pro.

69 Using Blackmagic Disk Speed Test

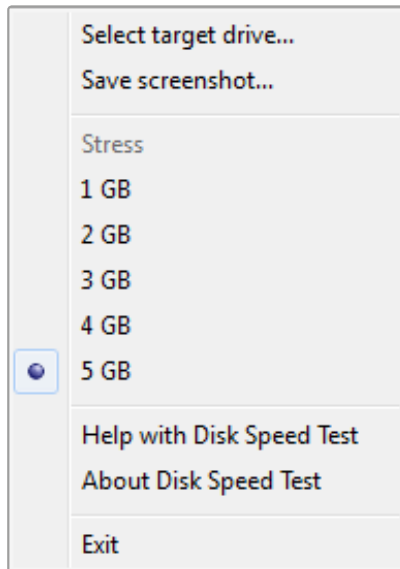

Settings menu

Using Blackmagic Disk Speed Test

Blackmagic Disk Speed Test is a beautiful and fun to use application that measures the read and write performance of storage media in video frame sizes. The use of video frame sizes provides accurate measurement of how the disk storage will perform with video related applications.

If you have ever wondered whether your hard drive is suitable for playback (“read”) of a particular video format, you can use Disk Speed Test to find out. With its easy to understand layout, it is now simple to understand what performance you can get out of your media drives with a single click of the Start button! Disk Speed Test will even show you how many streams of video your storage is capable of handling!

Disk Speed Test is included free with your HyperDeck and can also be downloaded from our website free of charge.

Disk Speed Test takes the guess work out of configuring your storage system for optimal performance for any job you will be doing.

Disk Speed Test settings are accessed by clicking on the Settings button, just above the Start button. On Mac OS X, the same settings are also available from the Menu Bar at the top of your computer display.

Select Target Drive

Click Select Target Drive to choose the storage volume you wish to test. Ensure you have Read and Write permissions for the selected volume as Disk Speed Test will write a temporary file to it. This file will be automatically deleted when you quit Disk Speed Test.

Save Screenshot

After testing your disk storage, click Save Screenshot to save a screenshot of the results to a chosen location.

Stress

Lower stress settings may be chosen if you want to demonstrate the speed of disk storage quickly. The 1 GB option would be a good choice on a trade show booth to rapidly show the read and write performance of a disk array even though the results might not be quite as accurate as when the 5 GB option is selected.

Disk Speed Test limits each write operation to a maximum of 8 seconds and each read operation to a maximum of 8 seconds so you do not have to wait long to obtain results.

Disk Speed Test Help

Click Disk Speed Test Help to launch the PDF manual for Disk Speed Test.

About Disk Speed Test

About Disk Speed Test displays which version of the Disk Speed Test you are running.

70 Using Blackmagic Disk Speed Test

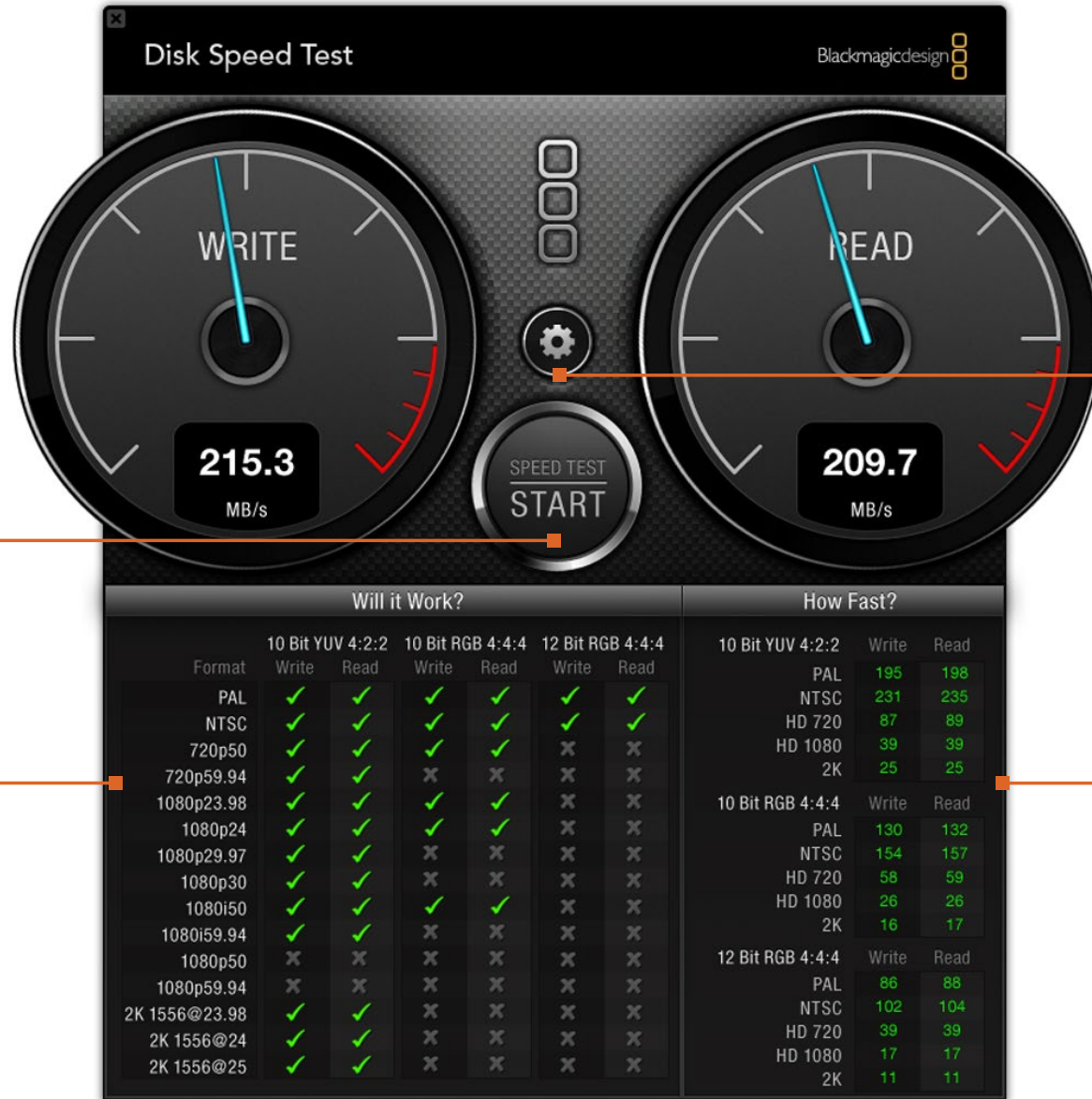

START
Click this button once to start the disk speed test. Click again to stop the test

Will it Work?
This panel shows which video formats can be supported by your disk storage

Settings
Click this button to access the settings before running a disk speed test

How Fast?
This panel shows results in frames per second (fps)

Will it Work?							How Fast?		
Format	10 Bit YUV 4:2:2		10 Bit RGB 4:4:4		12 Bit RGB 4:4:4		10 Bit YUV 4:2:2	Write	Read
	Write	Read	Write	Read	Write	Read	Write	Read	Read
PAL	✓	✓	✓	✓	✓	✓	PAL	195	198
NTSC	✓	✓	✓	✓	✓	✓	NTSC	231	235
720p50	✓	✓	✓	✓	✗	✗	HD 720	87	89
720p59.94	✓	✓	✗	✗	✗	✗	HD 1080	39	39
1080p23.98	✓	✓	✓	✓	✗	✗	2K	25	25
1080p24	✓	✓	✓	✓	✗	✗	10 Bit RGB 4:4:4		
1080p29.97	✓	✓	✗	✗	✗	✗	PAL	130	132
1080p30	✓	✓	✗	✗	✗	✗	NTSC	154	157
1080i50	✓	✓	✓	✓	✗	✗	HD 720	58	59
1080i59.94	✓	✓	✗	✗	✗	✗	HD 1080	26	26
1080p50	✗	✗	✗	✗	✗	✗	2K	16	17
1080p59.94	✗	✗	✗	✗	✗	✗	12 Bit RGB 4:4:4		
2K 1556@23.98	✓	✓	✗	✗	✗	✗	PAL	86	88
2K 1556@24	✓	✓	✗	✗	✗	✗	NTSC	102	104
2K 1556@25	✓	✓	✗	✗	✗	✗	HD 720	39	39
							HD 1080	17	17
							2K	11	11

71 Using Blackmagic Disk Speed Test

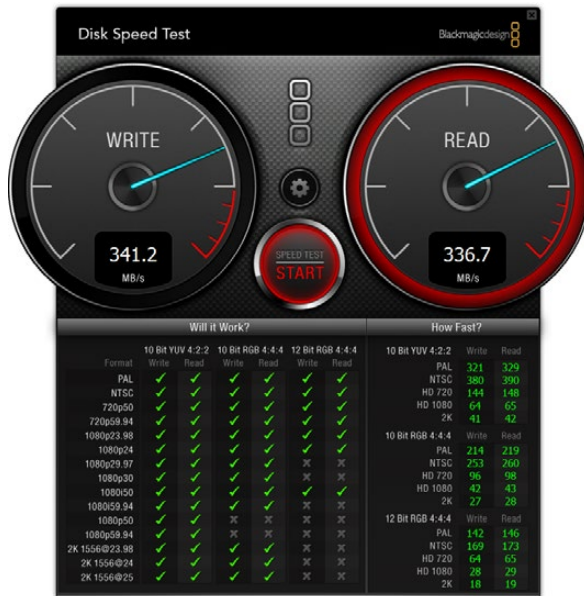

Disk Speed Test interface during a test

Start

Once you have chosen the desired settings, click the Start button to commence the disk speed test. Disk Speed Test will write a temporary file to the selected target drive. When the file has finished writing, or when 8 seconds has elapsed, Disk Speed Test will stop writing and start reading back the temporary file from the drive.

Disk Speed Test will continue writing and reading the nominated sized stress file until you stop the test by clicking the Start button again.

Will it Work?

The “Will it Work?” panel can help to identify video formats where the Read performance might be significantly different to the Write performance. These differences might mean that you can capture a video format but not play it back in real time or else you can play back a video format but not capture it in real time.

The “Will it Work?” panel shows common video formats and instantly displays a check mark or cross to show if the disk performance will be adequate for the desired video format. We suggest you allow Disk Speed Test to perform several test cycles to help reveal any video formats for which the disk storage performance might be marginal. If you observe a check mark and a cross switching between each other for a video format, this would indicate that the disk storage cannot reliably support the video format.

The “How Fast?” results panel shows the frame rates your drive can achieve in frames per second and should be read in conjunction with the “Will it Work?” panel. If the “Will it Work?” panel shows a green check mark for 1080p at 59.94fps in 10-Bit YUV 4:2:2, but the “How Fast?” panel shows that a maximum of 60fps will be supported, the disk storage performance is too marginal to be reliable.

How Fast?

After each Read or Write test, the results will be displayed in the “How Fast?” panel. The “How Fast?” results panel also enables you to see how many streams of video can be supported by your disk storage. If the result for “HD 1080” is 70, you can run up to 70 frames of HD 1080 video per second.

This storage speed is capable of supporting the following video formats:

- 2 simultaneous streams of 1080i50 video at 25 fps per stream
- 1 stream of 1080p50 video at 50 fps per stream
- 1 stream of 1080p59.94 video at 59.94 fps per stream

The contents of the box includes:

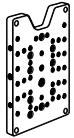

x1
HyperDeck Shuttle
Mounting Plate

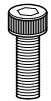

x4
Socket Head Screws
M3 x 10mm

You will need:



x1
Hex Allen Key 2.5mm
(not included)

Installing the HyperDeck Shuttle Mounting Plate

HyperDeck Shuttle Mounting Plate is an optional accessory that lets you secure your HyperDeck Shuttle to a camera rig with your choice of rail mounts, cold shoe mounts, articulated arms and more. You can also use the plate to power your HyperDeck Shuttle from an external battery by attaching a V-Mount or Anton Bauer style battery plate. HyperDeck Shuttle Mounting Plate is available for purchase from Blackmagic Design resellers. For easy installation, please follow these simple steps.

- Step 1.** Peel back the rubber mat from all four corners of the base so you can just see the screws. Remove all four screws.
- Step 2.** Remove the base.
- Step 3.** Attach your HyperDeck Shuttle Mounting Plate using the supplied socket head screws.

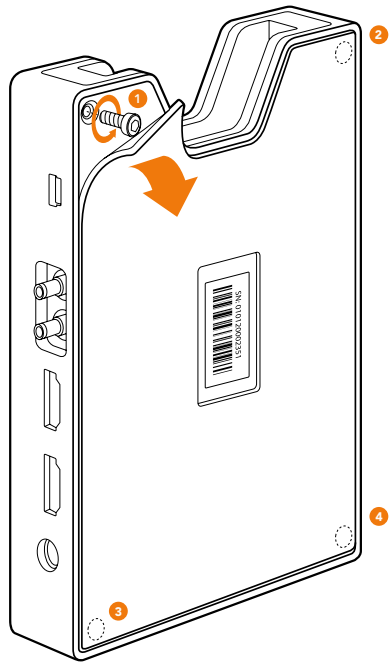

Step 1

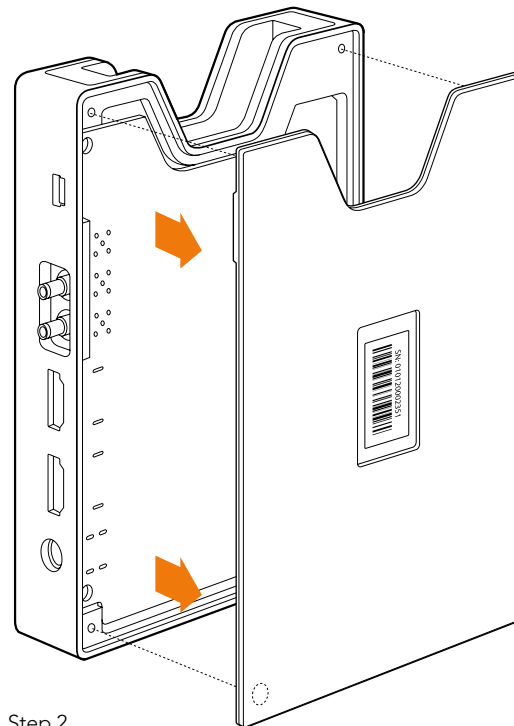

Step 2

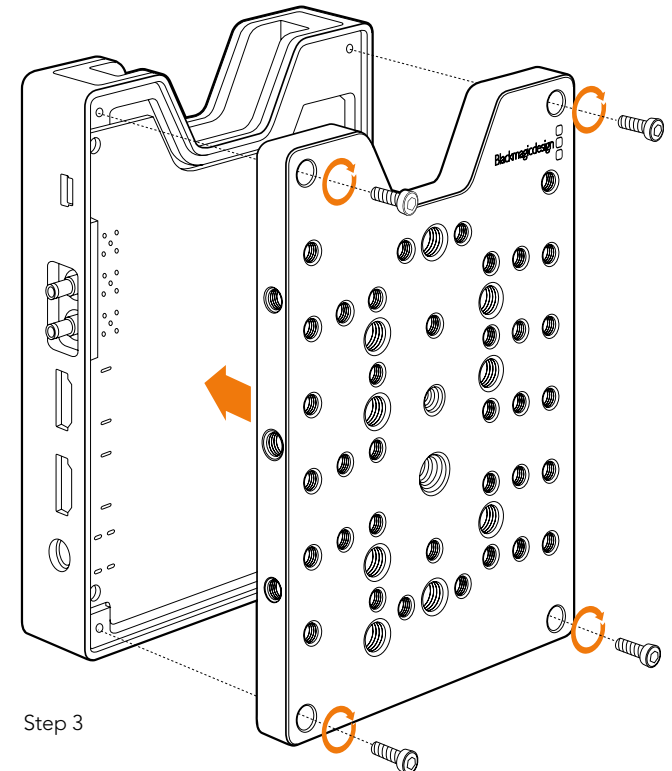

Step 3

Blackmagic HyperDeck Ethernet Protocol

Version 1.3

The Blackmagic HyperDeck Ethernet Protocol is a text based protocol accessed by connecting to TCP port 9993 on HyperDeck Studio models that have a built in Ethernet connection. If you are a software developer you can use the protocol to construct devices that integrate with our products. Here at Blackmagic Design our approach is to open up our protocols and we eagerly look forward to seeing what you come up with!

Protocol Commands

Command	Command Description
help or ?	Provides help text with all commands and parameters.
remote	Queries the state of HyperDeck's remote control mode.
remote: enable: true	Enables remote control.
remote: enable: false	disables remote control.
remote: override: true	Turns remote override on.
remote: override: false	Turns remote override off.
quit	Disconnects HyperDeck server.
ping	Determines HyperDeck server is responding.
preview: enable: true	Switches to HyperDeck preview mode.
preview: enable: false	Switches to HyperDeck output mode.
play	Starts playback all remaining clips on the timeline then stop.
play: speed: {% normal speed}	Starts playback at a specified speed in percentage between -1600 and 1600.
play: loop: true	Starts playback in looping fashion.
play: single clip: true	Starts playback the remaining of the current clip then stop.
record	Starts recording.
record: name: "{clip name}"	Starts recording a clip using a specified clip name.
stop	Stops playback or recording.
goto: clip id: {clip ID}	Goes to start of specific clip.
goto: clip: {"start", "end"}	Goes to start or end of current clip.

Command	Command Description
goto: timeline: {"start", "end"}	Goes to start of first clip or end of last clip.
goto: timecode: {timecode}	Goes to specified timecode
goto: timecode: {"+", "-"} {duration in timecode}	Moves forward or back a duration in timecode
commands	Lists all supported commands in an XML format.
notify	Queries the current state of all notifications.
notify: transport: true	Enables transport notifications.
notify: transport: false	Disables transport notifications.
notify: slot: true	Enables slot notifications.
notify: slot: false	Disables slot notifications.
notify: remote: true	Enables remote notifications.
notify: remote: false	Disables remote notifications.
notify: configuration: true	Enables configuration notifications.
notify: configuration: false	Disables configuration notifications.
device info	Provides information about the connected device.
slot info	Provides information about the current active slot.
slot info: slot id: {slot ID}	Provides information about a specified slot.
clips get	Provides information for each available clip.
transport info	Provides information for the state of the transport.
configuration	Queries the current configuration.
configuration: video input: {"SDI", "HDMI", "component"}	Configures video input.
configuration: audio input: {"embedded", "XLR", "RCA"}	Configures audio input.
configuration: file format: {File format}	Configures current file format.
slot select: video format: {Video format}	Reloads timeline with all clips of the specified video format.
slot select: slot id: {slot ID}	Switches to the specified slot.

Command Combinations

You can combine the parameters into a single command, for example:

```
play: speed: 200 loop: true single clip: true
```

Or for configuration:

```
configuration: video input: SDI audio input: XLR
```

Or to switch to the second disk, but only play NTSC clips:

```
slot select: slot id: 2 video format: NTSC
```

Using XML

While you can use the Terminal to talk to HyperDeck, if you are writing software you can use XML to confirm the existence of a specific command based on the firmware of the HyperDeck you are communicating with. This helps your software user interface adjust to the capabilities of the specific HyperDeck model and software version.

Protocol Details

Connection

The HyperDeck Ethernet server listens on TCP port 9993.

Basic syntax

The HyperDeck protocol is a line oriented text protocol. Lines from the server will be separated by an ascii CR LF sequence. Messages from the client may be separated by LF or CR LF.

New lines are represented in this document as a "`\n`" symbol.

Command syntax

Command parameters are usually optional. A command with no parameters is terminated with a new line:

```
{Command name}\n
```

If parameters are specified, the command name is followed by a colon, then pairs of parameter names and values. Each parameter name is terminated with a colon character:

```
{Command name}: {Parameter}: {Value} {Parameter}: {Value} ...\n
```

Response syntax

Simple responses from the server consist of a three digit response code and descriptive text terminated by a new line:

```
{Response code} {Response text}↵
```

If a response carries parameters, the response text is terminated with a colon, and parameter name and value pairs follow on subsequent lines until a blank line is returned:

```
{Response code} {Response text}:↵  
{Parameter}: {Value}↵  
{Parameter}: {Value}↵  
...  
↵
```

Successful response codes

A simple acknowledgement of a command is indicated with a response code of 200:

```
200 ok↵
```

Other successful responses carry parameters and are indicated with response codes in the range of 201 to 299.

Failure response codes

Failure responses to commands are indicated with response codes in the range of 100 to 199:

```
100 syntax error  
101 unsupported parameter  
102 invalid value  
103 unsupported  
104 disk full  
105 no disk  
106 disk error  
107 timeline empty  
109 out of range  
110 no input
```

```
111 remote control disabled
120 connection rejected
150 invalid state
```

Asynchronous response codes

The server may return asynchronous messages at any time. These responses are indicated with response codes in the range of 500 to 599:

```
5xx {Response Text}:↵
{Parameter}: {Value}↵
{Parameter}: {Value}↵
↵
```

Connection response

On connection, an asynchronous message will be delivered:

```
500 connection info:↵
protocol version: {Version}↵
model: {Model Name}↵
↵
```

Connection rejection

Only one client may connect to the server at a time. If other clients attempt to connect concurrently, they will receive an error and be disconnected:

```
120 connection rejected↵
```

Timecode syntax

Timecodes are expressed as non-drop-frame timecode in the format:

```
HH:MM:SS:FF
```

Handling of deck "remote" state

The "remote" command may be used to enable or disable the remote control of the deck. Any attempt to change the deck state over ethernet while remote access is disabled will generate an error:

```
111 remote control disabled↵
```

To enable or disable remote control:

```
remote: enable: {"true", "false"} ↵
```

The current remote control state may be overridden allowing remote access over ethernet irrespective of the current remote control state:

```
remote: override: {"true", "false"} ↵
```

The override state is only valid for the currently connected ethernet client and only while the connection remains open.

The "remote" command may be used to query the remote control state of the deck by specifying no parameters:

```
remote↵
```

The deck will return the current remote control state:

```
210 remote info:↵  
enabled: {"true", "false"}↵  
override: {"true", "false"}↵  
↵
```

Asynchronous remote control information change notification is disabled by default and may be configured with the "notify" command. When enabled, changes in remote state will generate a "510 remote info:" asynchronous message with the same parameters as the "210 remote info:" message.

Closing connection

The "quit" command instructs the server to cleanly shut down the connection:

```
quit↵
```

Checking connection status

The "ping" command has no function other than to determine if the server is responding:

```
ping↵
```

Getting help

The "help" or "?" commands return human readable help text describing all available commands and parameters:

```
help↵
```

Or:

```
?↵
```

The server will respond with a list of all supported commands:

```
201 help:↵
{Help Text}↵
{Help Text}↵
↵
```

Switching to preview mode

The "preview" command instructs the deck to switch between preview mode and output mode:

```
preview: enable: {"true", "false"}↵
```

Playback will be stopped when the deck is switched to preview mode. Capturing will be stopped when the deck is switched to output mode.

Controlling device playback

The "play" command instructs the deck to start playing:

```
play↵
```

The play command accepts a number of parameters which may be used together in most combinations.

By default, the deck will play all remaining clips on the timeline then stop. The "single clip" parameter may be used to override this behaviour:

```
play: single clip: {"true", "false"}↵
```

By default, the deck will play at normal (100%) speed. An alternate speed may be specified in percentage between -1600 and 1600:

```
play: speed: {% normal speed}↵
```

By default, the deck will stop playing when it reaches to the end of the timeline. The "loop" parameter may be used to override this behaviour:

```
play: loop: {"true", "false"}↵
```

By default, the deck will start playing from the current position on the timeline. The "start" parameter may be specified to override the start-point for playback:

```
play: start: {timecode}↵
```

If loop mode is set, the playback loop will be between:
the "start" position and the end of timeline for play forward,
the "start" position and the start of timeline for play backward.

By default the deck will continue playing until the end of the timeline. The "end" parameter may be used to halt playback at the frame before the specified timecode:

```
play: end: {timecode}↵
```

If loop mode is set, the playback loop will be between:
the start of timeline and the "end" position for play forward,
the end of timeline and the "end" position for play backward.

Note that the "end" position must be:

beyond the current/or start position on timeline for play forward,
before the current/or start position on timeline for play backward.

The "duration" parameter may be used instead of the "end" parameter to halt playback after a duration specified in timecode format:

```
play: duration: {timecode}↵
```

These three parameters are not compatible with the "single clip" parameter.

Stopping deck operation

The "stop" command instructs the deck to stop the current playback or capture:

```
stop↵
```

Changing timeline position

The "goto" command instructs the deck to switch to playback mode and change its position within the timeline.

To go to the start of a specific clip:

```
goto: clip id: {Clip ID}↵
```

To move forward/back {count} clips from the current clip on the current timeline:

```
goto: clip id: +/-{count}↵
```

Note that if the resultant clip id goes beyond the first or last clip on timeline, it will be clamp at the first or last clip.

To go to the start or end of the current clip:

```
goto: clip: {"start", "end"}↵
```

To go to the start of the first clip or the end of the last clip:

```
goto: timeline: {"start", "end"}↵
```

To go to a specified timecode:

```
goto: timecode: {timecode}↵
```

To move forward or back a specified duration in timecode:

```
goto: timecode: {"+", "-"}{duration in timecode}↵
```

Note that only one parameter/value pair is allowed for each goto command.

Enumerating supported commands and parameters

The "commands" command returns the supported commands:

```
commands↵
```

The command list is returned in a computer readable XML format:

212 commands:

```
<commands>↵  
  <command name="..."><parameter name="..."/>...</command>↵  
  <command name="..."><parameter name="..."/>...</command>↵  
  ...  
</commands>↵  
↵
```

More XML tokens and parameters may be added in later releases.

Controlling asynchronous notifications

The "notify" command may be used to enable or disable asynchronous notifications from the server. To enable or disable transport notifications:

```
notify: transport: {"true", "false"}↵
```

To enable or disable slot notifications:

```
notify: slot: {"true", "false"}↵
```

To enable or disable remote notifications:

```
notify: remote: {"true", "false"}↵
```

To enable or disable configuration notifications:

```
notify: configuration: {"true", "false"}↵
```

Multiple parameters may be specified. If no parameters are specified, the server returns the current state of all notifications:

```
209 notify:↵
transport: {"true", "false"}↵
slot: {"true", "false"}↵
remote: {"true", "false"}↵
configuration: {"true", "false"}↵
↵
```

Retrieving device information

The "device info" command returns information about the connected deck device:

```
device info↵
```

The server will respond with:

```
204 device info:↵
protocol version: {Version}↵
model: {Model Name}↵
unique id: {unique alphanumeric identifier}↵
↵
```

Retrieving slot information

The "slot info" command returns information about a slot. Without parameters, the command returns information for the currently selected slot:

```
slot info↵
```

If a slot id is specified, that slot will be queried:

```
slot info: slot id: {Slot ID}↵
```

The server will respond with slot specific information:

```
202 slot info:↵
slot id: {Slot ID}↵
status: {"empty", "mounting", "error", "mounted"}↵
volume name: {Volume name}↵
```

```

recording time: {recording time available in seconds}↵
video format: {disk's default video format}↵
↵

```

Asynchronous slot information change notification is disabled by default and may be configured with the "notify" command. When enabled, changes in slot state will generate a "502 slot info:" asynchronous message with the same parameters as the "202 slot info:" message.

Retrieving clip information

The "disk list" command returns the information for each playable clip on a given disk. Without parameters, the command returns information for the current active disk:

```
disk list↵
```

If a slot id is specified, the disk in that slot will be queried:

```
disk list: slot id: {Slot ID}↵
```

The server responds with the list of all playable clips on the disk in the format of: Index, name, formats, and duration in timecode:

```

206 disk list:↵
slot id: {Slot ID}↵
{clip index}: {name} {file format} {video format} {Duration
timecode}↵
{clip index}: {name} {file format} {video format} {Duration
timecode}↵
...
↵

```

Note that the *clip index* starts from 1.

Retrieving clip count

The "clips count" command returns the number of clips on the current timeline:

```
clips count ↵
```

The server responds with the number of clips:

```

214 clips count: ↵
clip count: {Count}↵

```

Retrieving timeline information

The "clips get" command returns information for each available clip, for a given range in timecode, on the current timeline. Without parameters, the command returns information for all clips on timeline:

```
clips get↵
```

If parameters "in: *timecode*" and "out: *timecode*" are specified, the command returns information for clips within the specified range.

If "out: " is not specified, it only returns the information of the clip containing in "in: " point.

```
clips get: in: {timecode} out: {timecode}↵
```

The server responds with a list of clip IDs, names and timecodes:

```
205 clips info:↵
clip count: {Count}↵
{Clip ID}: {Name} {Start timecode} {Duration timecode}↵
{Clip ID}: {Name} {Start timecode} {Duration timecode}↵
...
↵
```

Note that the clip list format has changed incompatibly in protocol version 1.1,

i.e., *Start timecode* information field is inserted to each clip information line.

Retrieving transport information

The "transport info" command returns the state of the transport:

```
transport info ↵
```

The server responds with transport specific information:

```
208 transport info:↵
status: {"preview", "stopped", "play", "forward", "rewind",
"jog", "shuttle","record"}↵
speed: {Play speed between -1600 and 1600 %}↵
slot id: {Slot ID or "none"}↵
display timecode: {timecode}↵
timecode: {timecode}↵
```

```
clip id: {Clip ID or "none"}↵  
video format: {Video format}↵  
loop: {"true", "false"}↵  
↵
```

The "timecode" value is the timecode within the current timeline for playback or the clip for record. The "display timecode" is the timecode displayed on the front of the deck. The two timecodes will differ in some deck modes.

Asynchronous transport information change notification is disabled by default and may be configured with the "notify" command. When enabled, changes in transport state will generate a "508 transport info:" asynchronous message with the same parameters as the "208 transport info:" message.

Video Formats

The following video formats are currently supported on HyperDeck Studio:

NTSC, PAL, NTSCp, PALp

720p50, 720p5994, 720p60

1080p23976, 1080p24, 1080p25, 1080p2997, 1080p30

1080i50, 1080i5994, 1080i60

HyperDeck Studio Pro adds supports for 4k formats:

4Kp23976, 4Kp24, 4Kp25, 4Kp2997, 4Kp30

HyperDeck Studio 12G adds support for the following 4k formats:

4Kp50, 4Kp5994, 4Kp60

Video format support may vary between models and software releases.

File Formats

The HyperDeck Studio and HyperDeck Studio Pro currently support the following file formats:

QuickTimeUncompressed

QuickTimeProResHQ

QuickTimeProRes

QuickTimeProResLT

QuickTimeProResProxy

The HyperDeck Studio Pro and HyperDeck Studio 12G additionally support the following file formats:

QuickTimeDNxHR220

DNxHR220

Supported file formats may vary between models and software releases.

Querying and updating configuration information

The "configuration" command may be used to query the current configuration of the deck:

```
configuration↵
```

The server returns the configuration of the deck:

```
211 configuration:↵
audio input: {"embedded", "XLR", "RCA"}↵
video input: {"SDI", "HDMI", "component"}↵
file format: {File format}↵
↵
```

One or more configuration parameters may be specified to change the configuration of the deck.

To change the current video input:

```
configuration: video input: {"SDI", "HDMI", "component"}↵
```

Valid video inputs may vary between models. To configure the current audio input:

```
configuration: audio input: {"embedded", "XLR", "RCA"}↵
```

Valid audio inputs may vary between models.

To configure the current file format:

```
configuration: file format: {File format}↵
```

Note that changes to the file format may require the deck to reset, which will cause the client connection to be closed. In such case, response code 213 will be returned (instead of 200) before the client connection is closed:

```
"213 deck rebooting"
```

Asynchronous configuration information change notification is disabled by default and may be configured with the "notify" command. When enabled, changes in configuration will generate a "511 configuration:" asynchronous message with the same parameters as the "211 configuration:" message.

Selecting active slot and video format

The "slot select" command instructs the deck to switch to a specified slot, or/and to select a specified output video format.

To switch to a specified slot:

```
slot select: slot id: {slot ID}↵
```

To select the output video format:

```
slot select: video format: {video format}↵
```

Either or all slot select parameters may be specified. Note that selecting video format will result in a rescan of the disk to reconstruct the timeline with all clips of the specified video format.

Clearing the current timeline

The "clips clear" command instructs the deck to empty the current timeline:

```
clips clear↵
```

The server responds with

```
200 ok↵
```

Adding a clip to the current timeline

The "clips add:" command instructs the deck to add a clip to the current timeline:

```
clips add: name: {"clip name"}↵
```

The server responds with

```
200 ok↵
```

or in case of error

```
1xx {error description}↵
```

Configuring the watchdog

The "watchdog" command instructs the deck to monitor the connected client and terminate the connection if the client is inactive for at least a specified period of time.

To configure the watchdog:

```
watchdog: period: {period in seconds}↵
```

To avoid disconnection, the client must send a command to the server at least every {period} seconds. Note that if the period is set to 0 or less than 0, connection monitoring will be disabled.

Getting Help

The fastest way to obtain help is to go to the Blackmagic Design online support pages and check the latest support material available for your HyperDeck.

Blackmagic Design Online Support Pages

The latest manual, software and support notes can be found at the Blackmagic Design support center at www.blackmagicdesign.com/support.

Contacting Blackmagic Design Support

If you can't find the help you need in our support material, please use the "Send us an email" button on the support page to email a support request. Alternatively, click on the "Find your local support team" button on the support page and call your nearest Blackmagic Design support office.

Checking the Software Version Currently Installed

To check which version of Blackmagic HyperDeck Setup is installed on your computer, open the About Blackmagic HyperDeck Setup window.

- On Mac OS X, open Blackmagic HyperDeck Setup from the Applications folder. Select About Blackmagic HyperDeck Setup from the application menu to reveal the version number.
- On Windows, open Blackmagic HyperDeck Setup from your Start menu or Start Screen. Click on the Help menu and select About Blackmagic HyperDeck Setup to reveal the version number.

How to Get the Latest Software Updates

After checking the version of HyperDeck utility software installed on your computer, please visit the Blackmagic Design support center at www.blackmagicdesign.com/support to check for the latest updates. While it is usually a good idea to run the latest updates, it is a wise practice to avoid updating any software if you are in the middle of an important project.



Example of caution label on rear panel

Warnetikett auf der Rückseite

Avertissement sur le panneau arrière

Caution: Risk of Electric Shock

On HyperDeck Studio Pro's rear panel you will see a warning label marked 'Caution: Risk of Electric Shock'. This is intended to warn users that there may be the presence of uninsulated "dangerous" voltage within HyperDeck Studio Pro's enclosure which may be of sufficient magnitude to constitute a risk of electric shock to the user. Blackmagic Design advises you not to open the HyperDeck Studio Pro unit, but rather contact your nearest Blackmagic Design service center should assistance be required.

Achtung: Stromschlaggefahr

Auf der HyperDeck Studio Pro-Rückseite befindet sich ein Warnetikett mit der Aufschrift 'Caution: Risk of Electric Shock'. Dieses warnt den Benutzer vor einer möglichen, nicht isolierten, "gefährlichen" Spannung innerhalb des HyperDeck Studio Pro-Gehäuses, die einen Elektroschock verursachen kann. Blackmagic Design empfiehlt das Gehäuse des HyperDeck Studio Pro nicht selbst zu öffnen, sondern bei Hilfebedarf das nächstgelegene Blackmagic Design Servicecenter zu kontaktieren.

Attention: Risque de choc électrique

Sur le panneau arrière du HyperDeck Studio Pro, vous verrez une étiquette d'avertissement sur laquelle est inscrit « Attention : Risque de choc électrique ». Cette mise en garde est destinée à avertir les utilisateurs de la présence possible d'une tension « dangereuse » non isolée à l'intérieur du boîtier du HyperDeck Studio Pro, laquelle tension pouvant avoir une magnitude suffisante pour constituer un risque de choc électrique à l'utilisateur. Blackmagic Design vous déconseille donc d'ouvrir l'unité HyperDeck Studio Pro, et vous recommande de contacter votre centre de service Blackmagic Design le plus proche en cas de nécessité.

12 Month Limited Warranty

Blackmagic Design warrants that this product will be free from defects in materials and workmanship for a period of 12 months from the date of purchase. If a product proves to be defective during this warranty period, Blackmagic Design, at its option, either will repair the defective product without charge for parts and labor, or will provide a replacement in exchange for the defective product.

In order to obtain service under this warranty, you the Customer, must notify Blackmagic Design of the defect before the expiration of the warranty period and make suitable arrangements for the performance of service. The Customer shall be responsible for packaging and shipping the defective product to a designated service center nominated by Blackmagic Design, with shipping charges pre paid. Customer shall be responsible for paying all shipping charges, insurance, duties, taxes, and any other charges for products returned to us for any reason.

This warranty shall not apply to any defect, failure or damage caused by improper use or improper or inadequate maintenance and care. Blackmagic Design shall not be obligated to furnish service under this warranty: a) to repair damage resulting from attempts by personnel other than Blackmagic Design representatives to install, repair or service the product, b) to repair damage resulting from improper use or connection to incompatible equipment, c) to repair any damage or malfunction caused by the use of non Blackmagic Design parts or supplies, or d) to service a product that has been modified or integrated with other products when the effect of such a modification or integration increases the time or difficulty of servicing the product. THIS WARRANTY IS GIVEN BY BLACKMAGIC DESIGN IN LIEU OF ANY OTHER WARRANTIES, EXPRESS OR IMPLIED. BLACKMAGIC DESIGN AND ITS VENDORS DISCLAIM ANY IMPLIED WARRANTIES OF MERCHANTABILITY OR FITNESS FOR A PARTICULAR PURPOSE. BLACKMAGIC DESIGN'S RESPONSIBILITY TO REPAIR OR REPLACE DEFECTIVE PRODUCTS IS THE WHOLE AND EXCLUSIVE REMEDY PROVIDED TO THE CUSTOMER FOR ANY INDIRECT, SPECIAL, INCIDENTAL OR CONSEQUENTIAL DAMAGES IRRESPECTIVE OF WHETHER BLACKMAGIC DESIGN OR THE VENDOR HAS ADVANCE NOTICE OF THE POSSIBILITY OF SUCH DAMAGES. BLACKMAGIC DESIGN IS NOT LIABLE FOR ANY ILLEGAL USE OF EQUIPMENT BY CUSTOMER. BLACKMAGIC IS NOT LIABLE FOR ANY DAMAGES RESULTING FROM USE OF THIS PRODUCT. USER OPERATES THIS PRODUCT AT OWN RISK.

© Copyright 2015 Blackmagic Design. All rights reserved. 'Blackmagic Design', 'DeckLink', 'HDLINK', 'Workgroup Videohub', 'Multibridge Pro', 'Multibridge Extreme', 'Intensity' and 'Leading the creative video revolution' are registered trademarks in the US and other countries. All other company and product names may be trade marks of their respective companies with which they are associated.